

20.55.1301.00

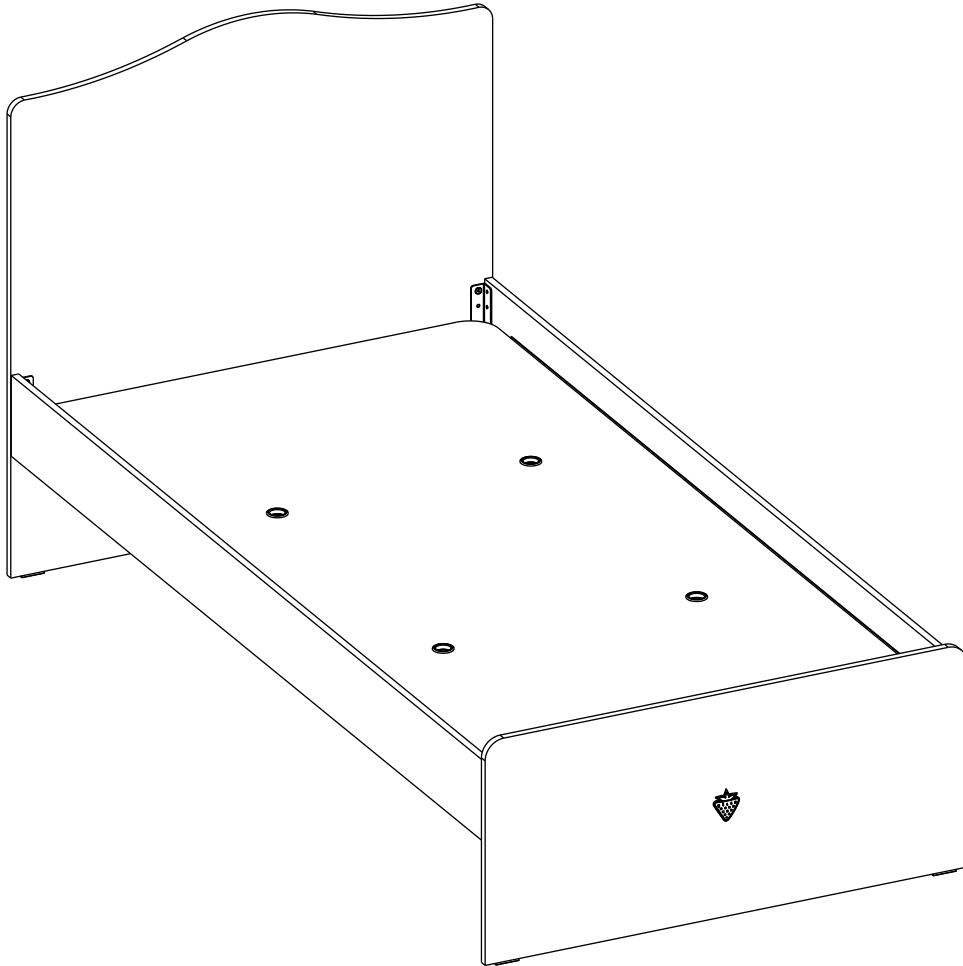

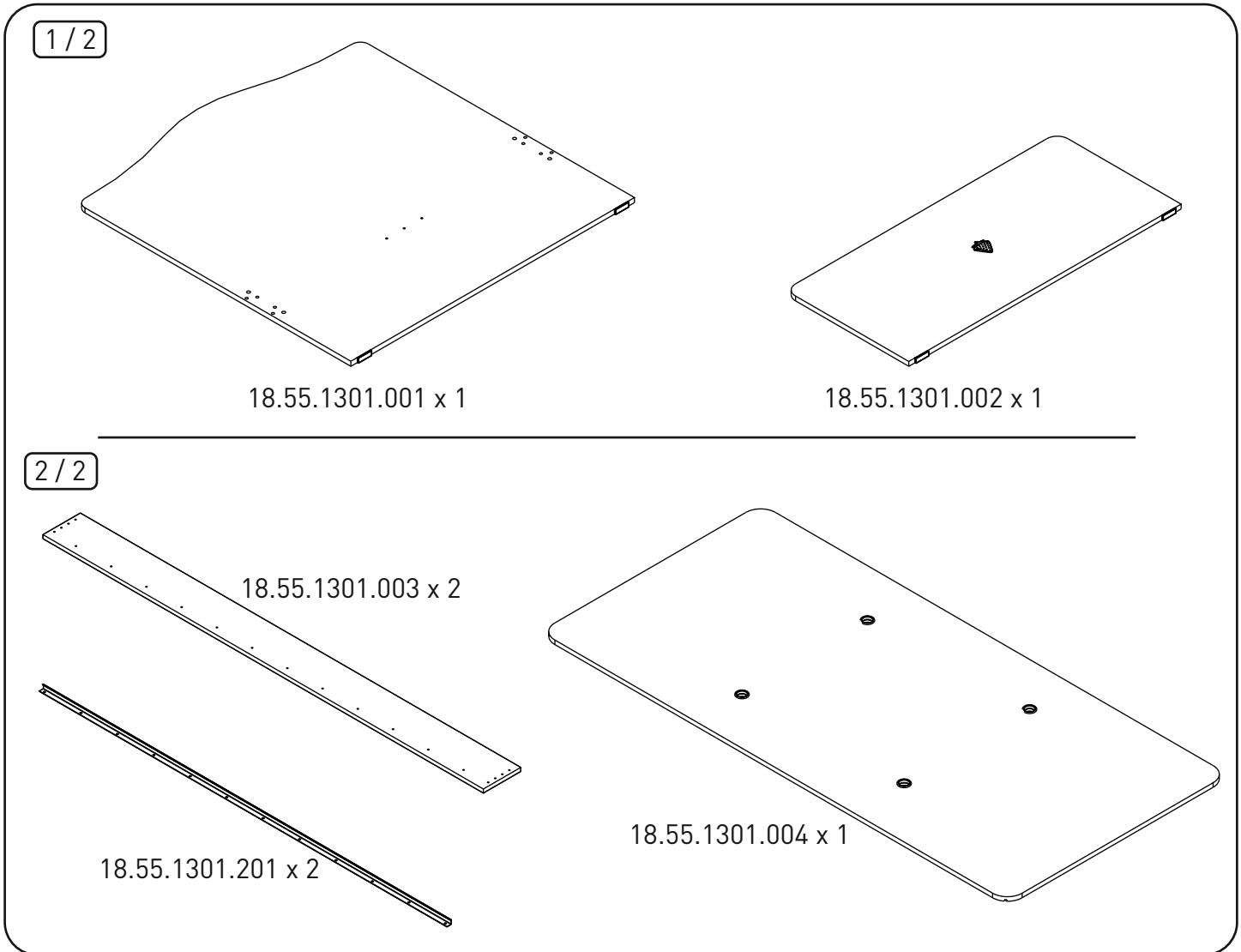

1

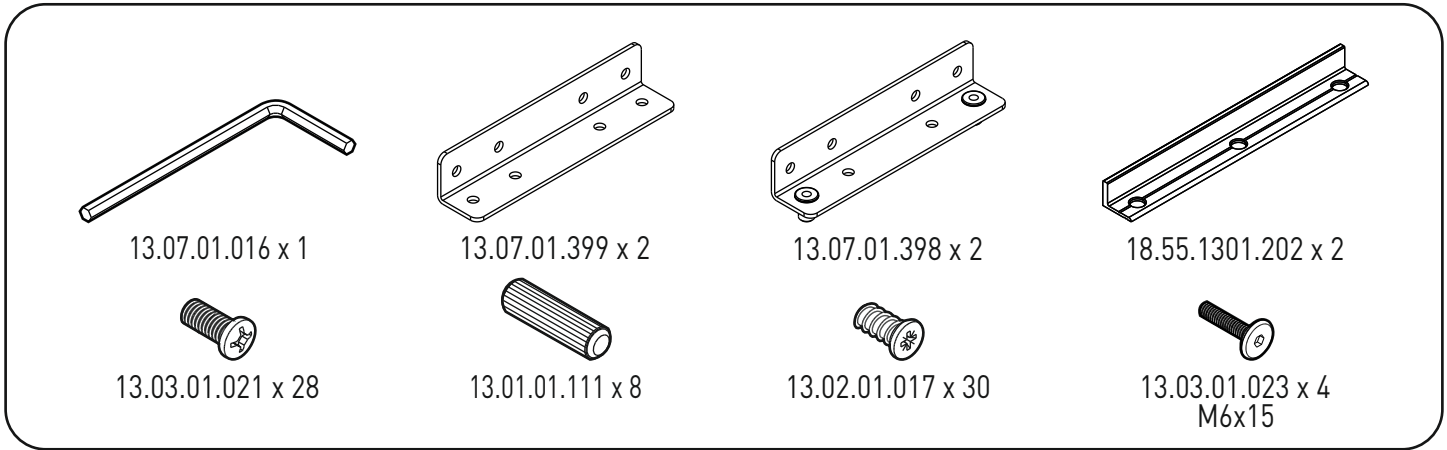
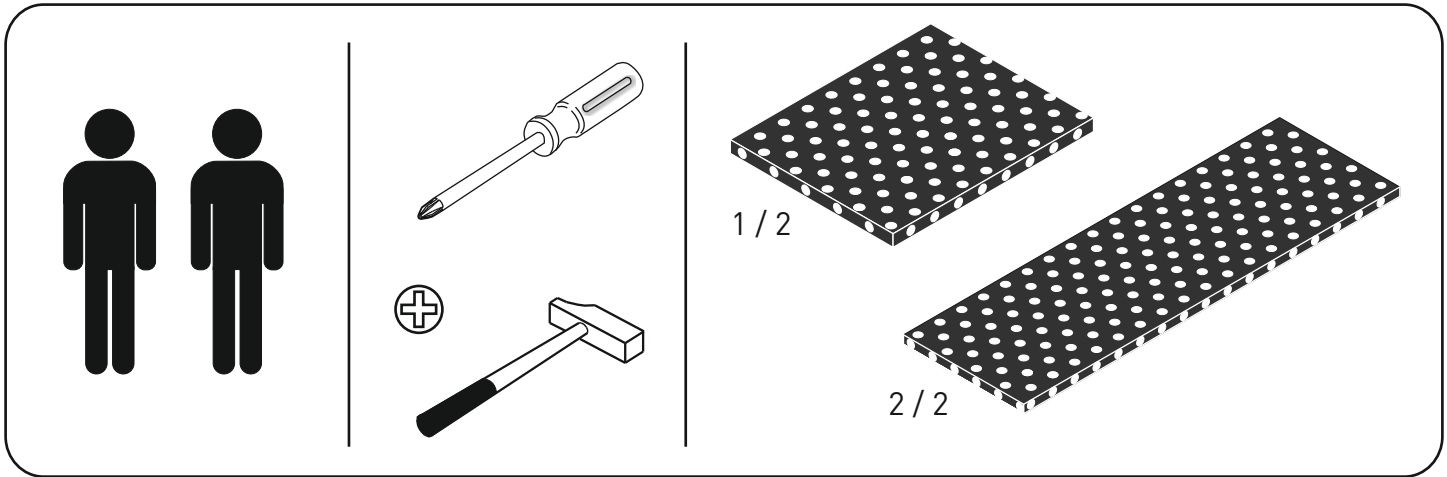
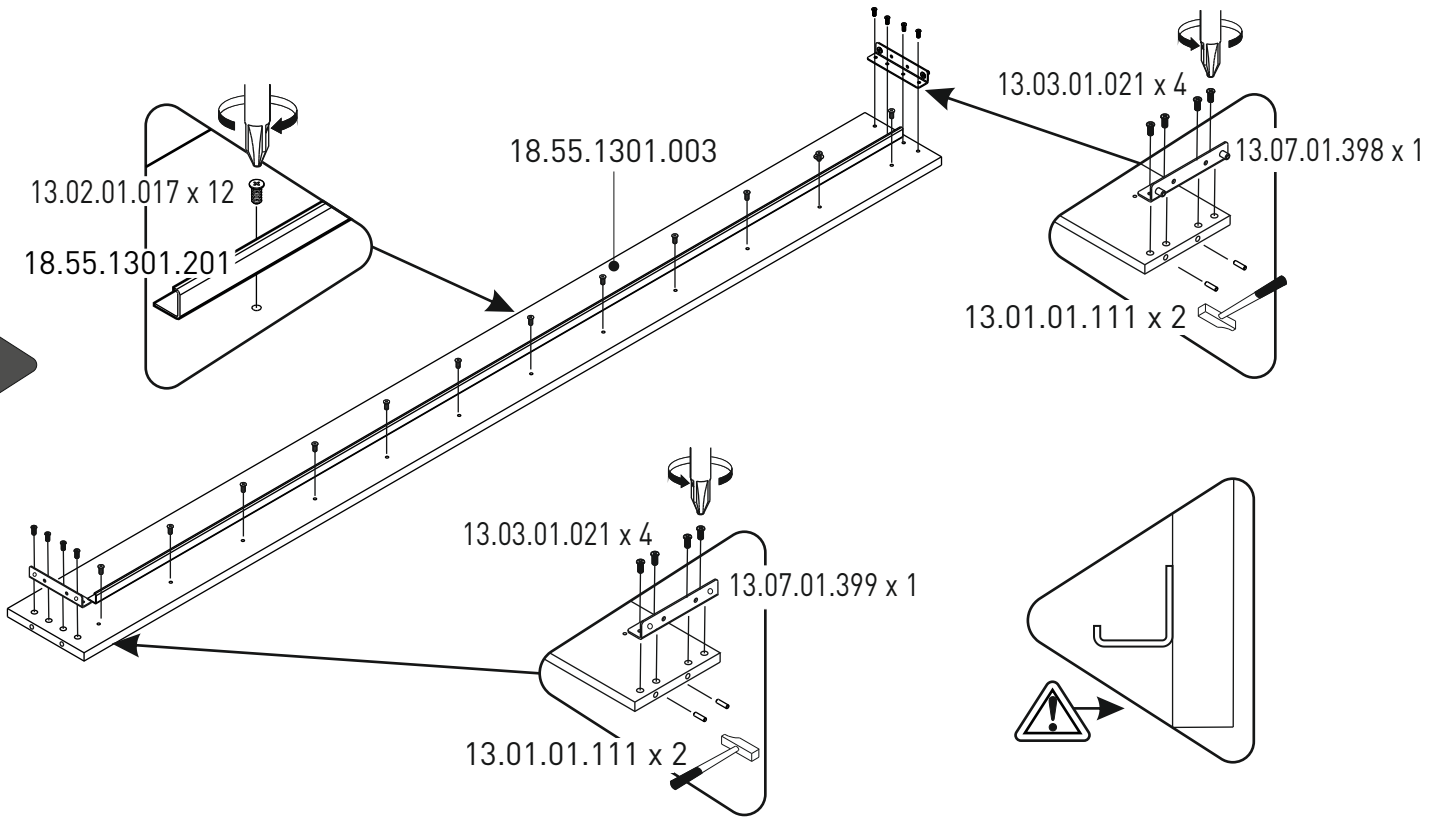

2

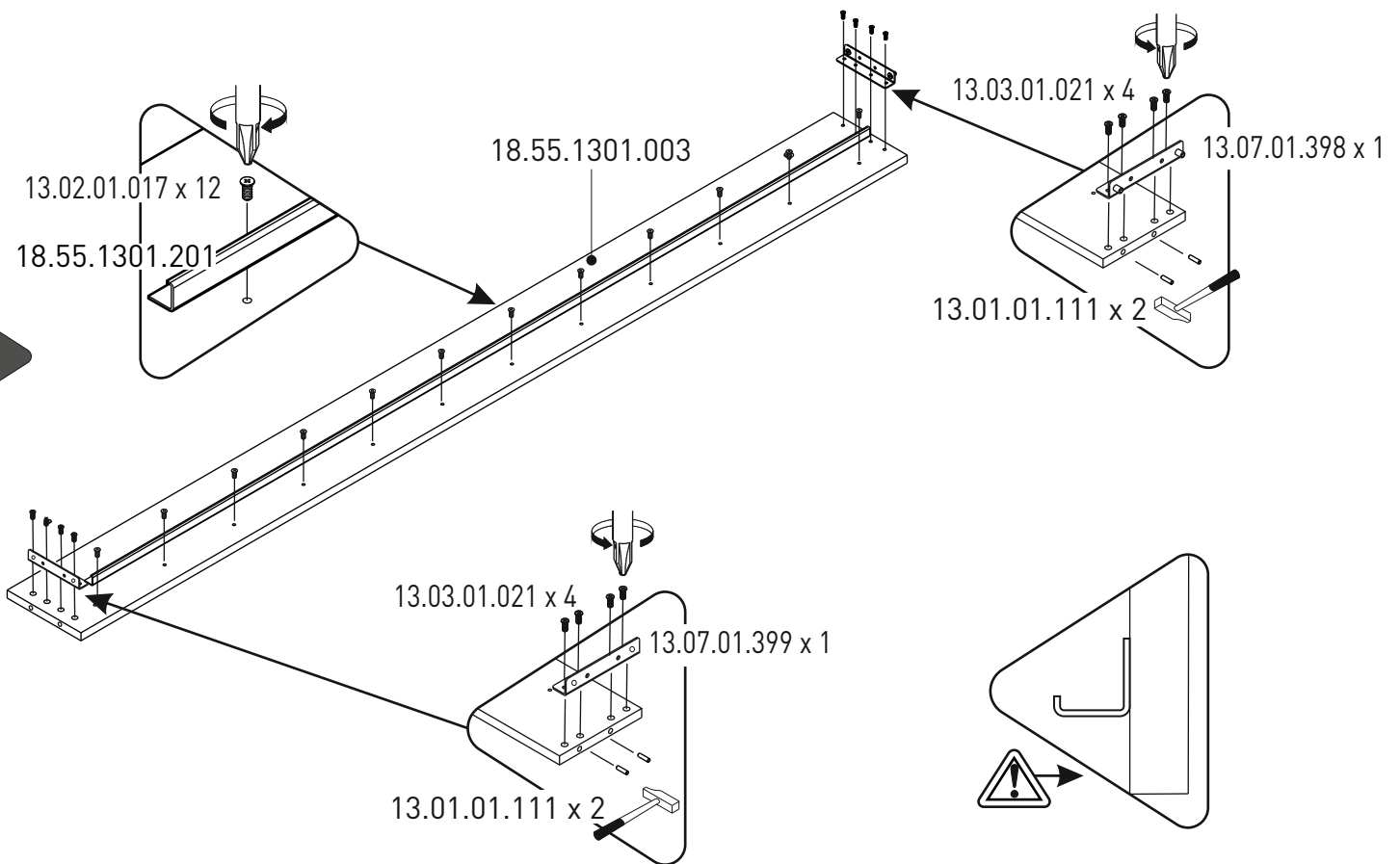

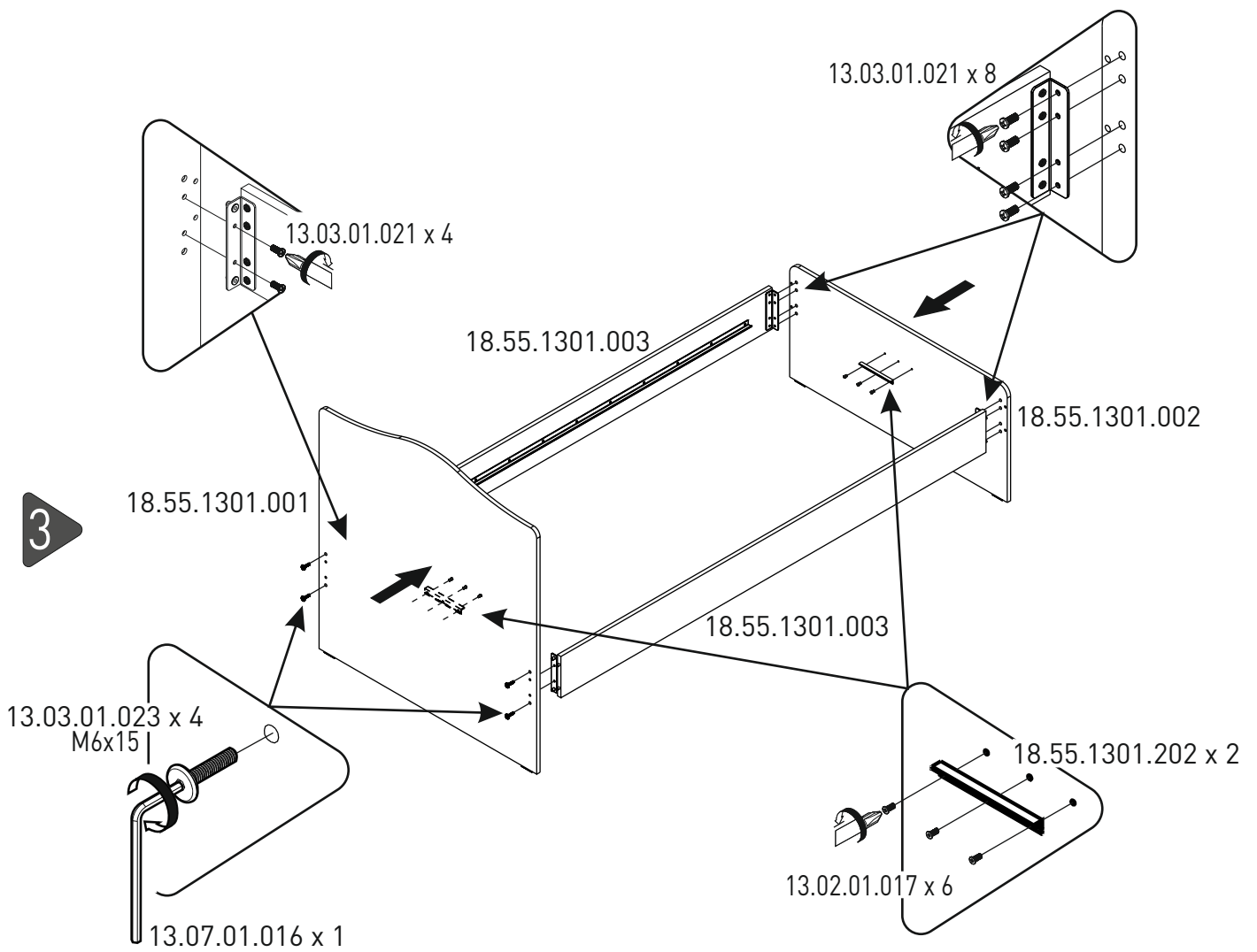

4

