

20.55.1303.00

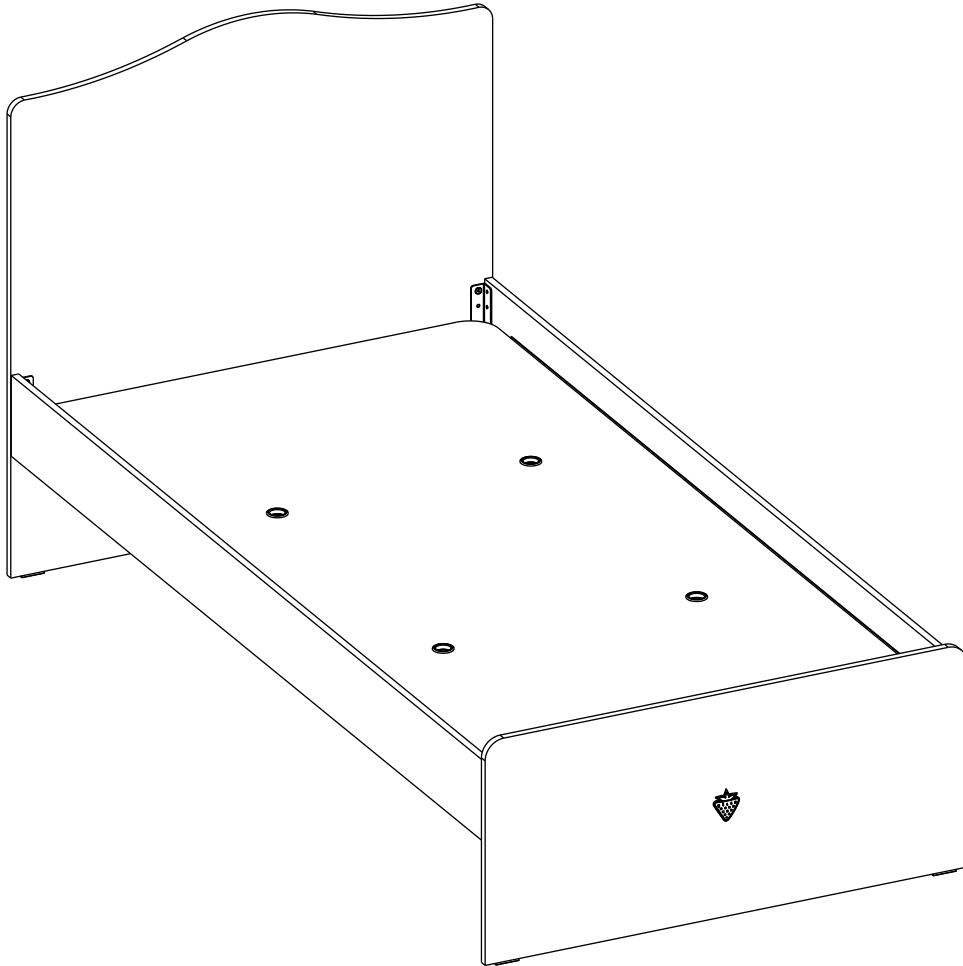

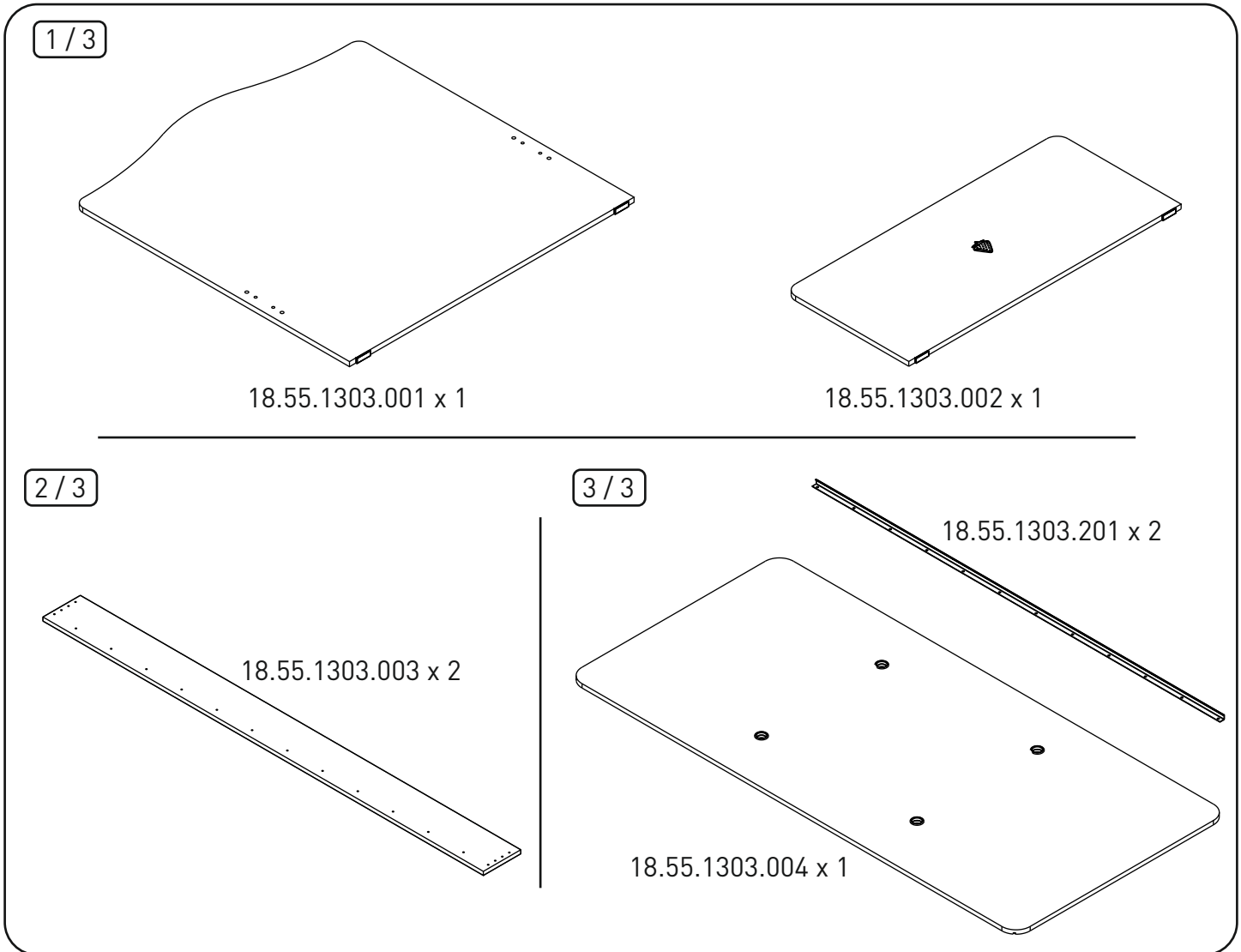

1

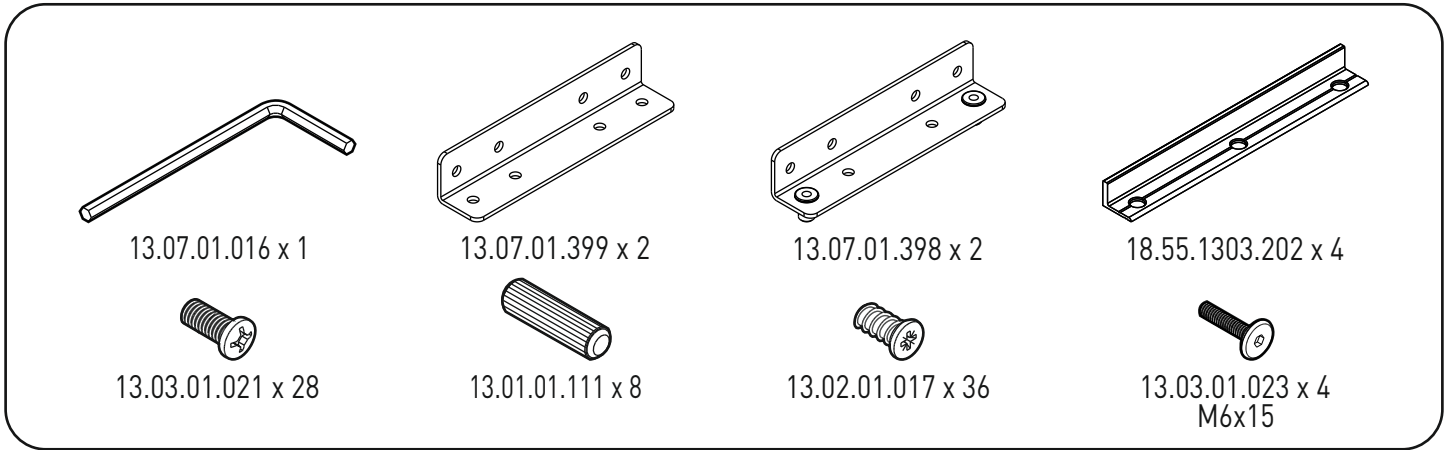
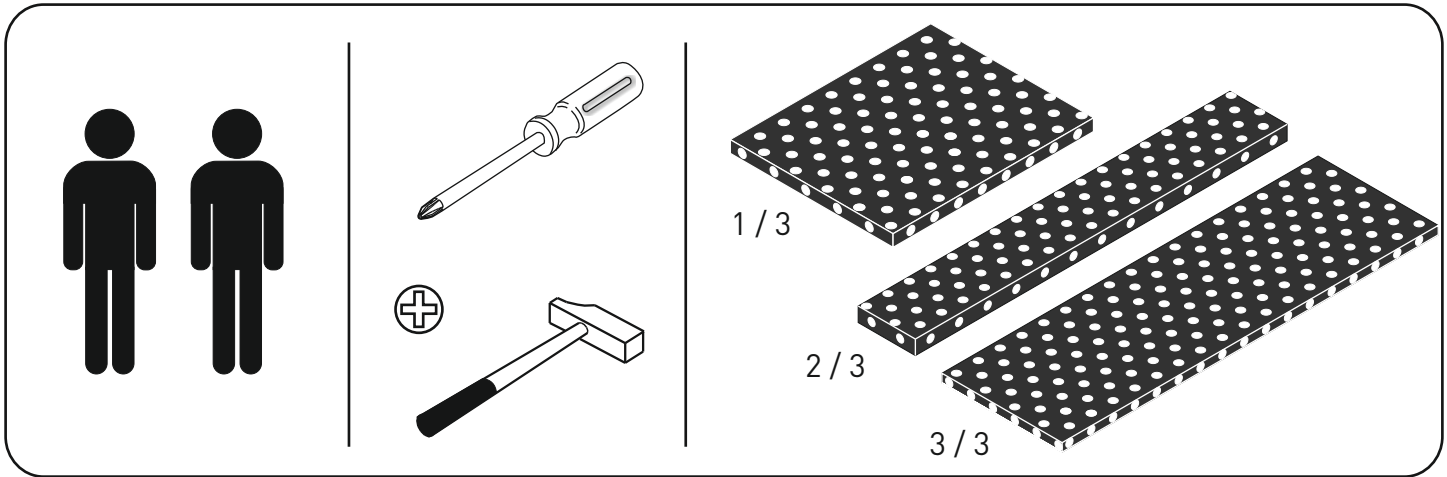
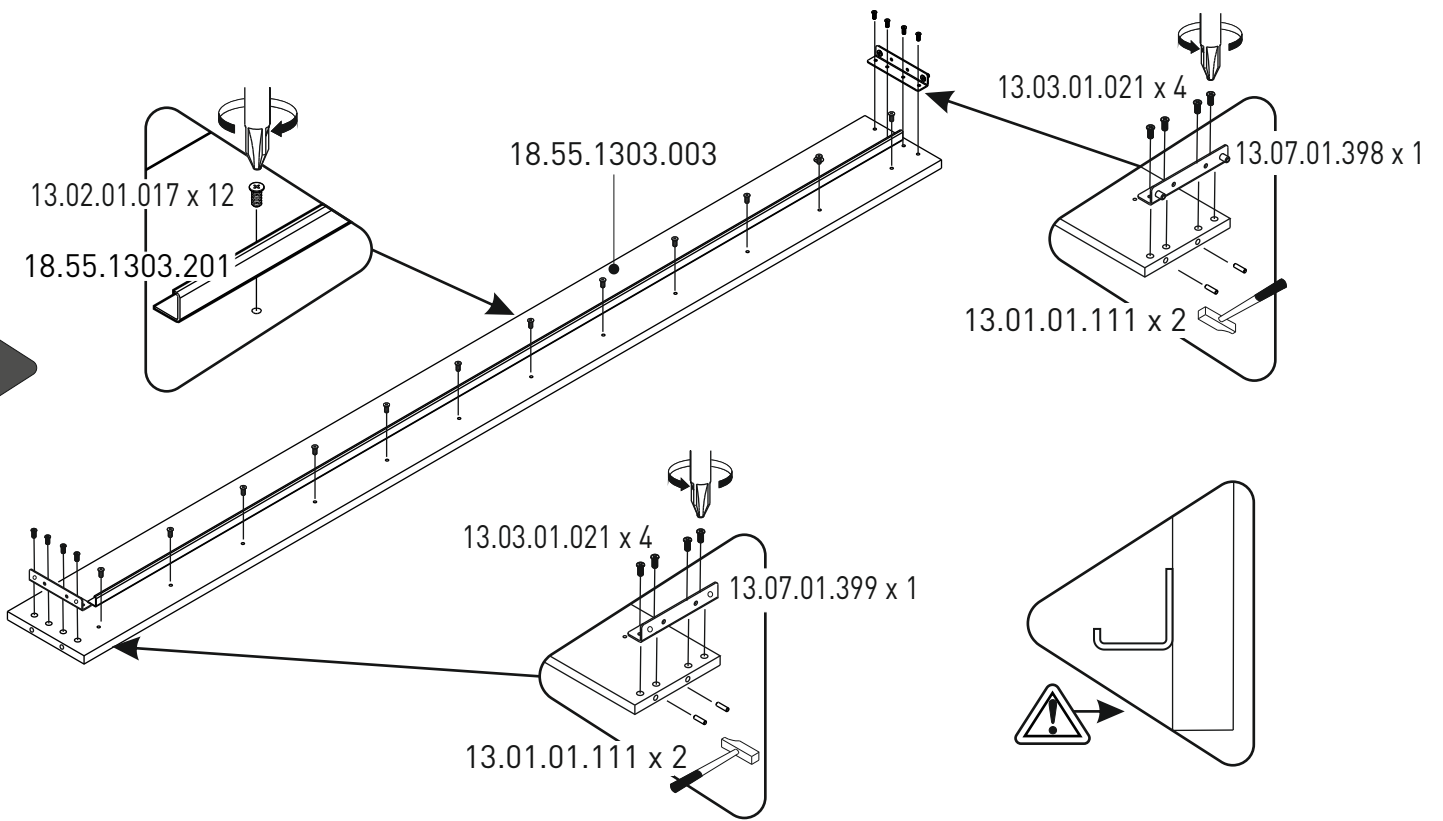

2

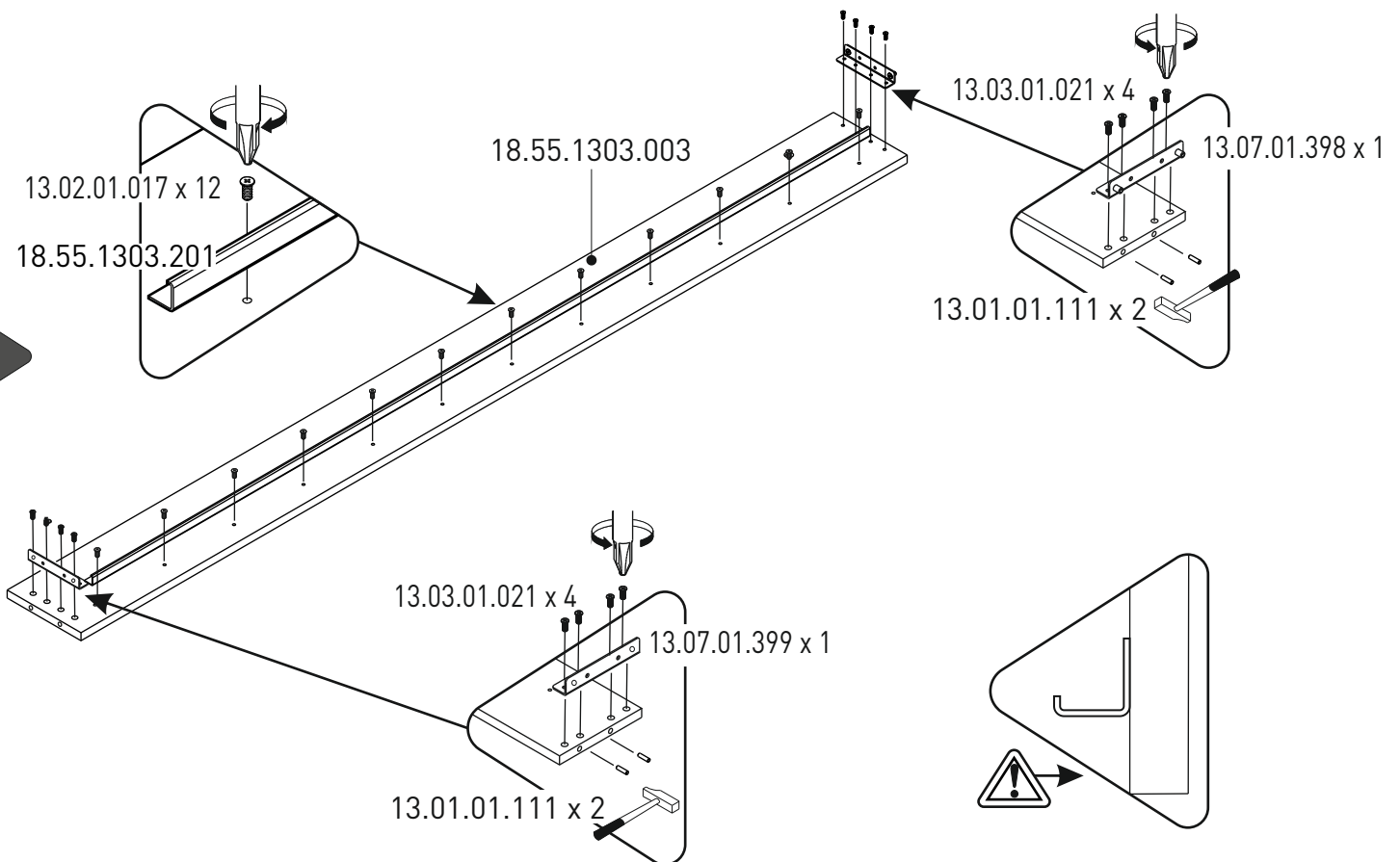

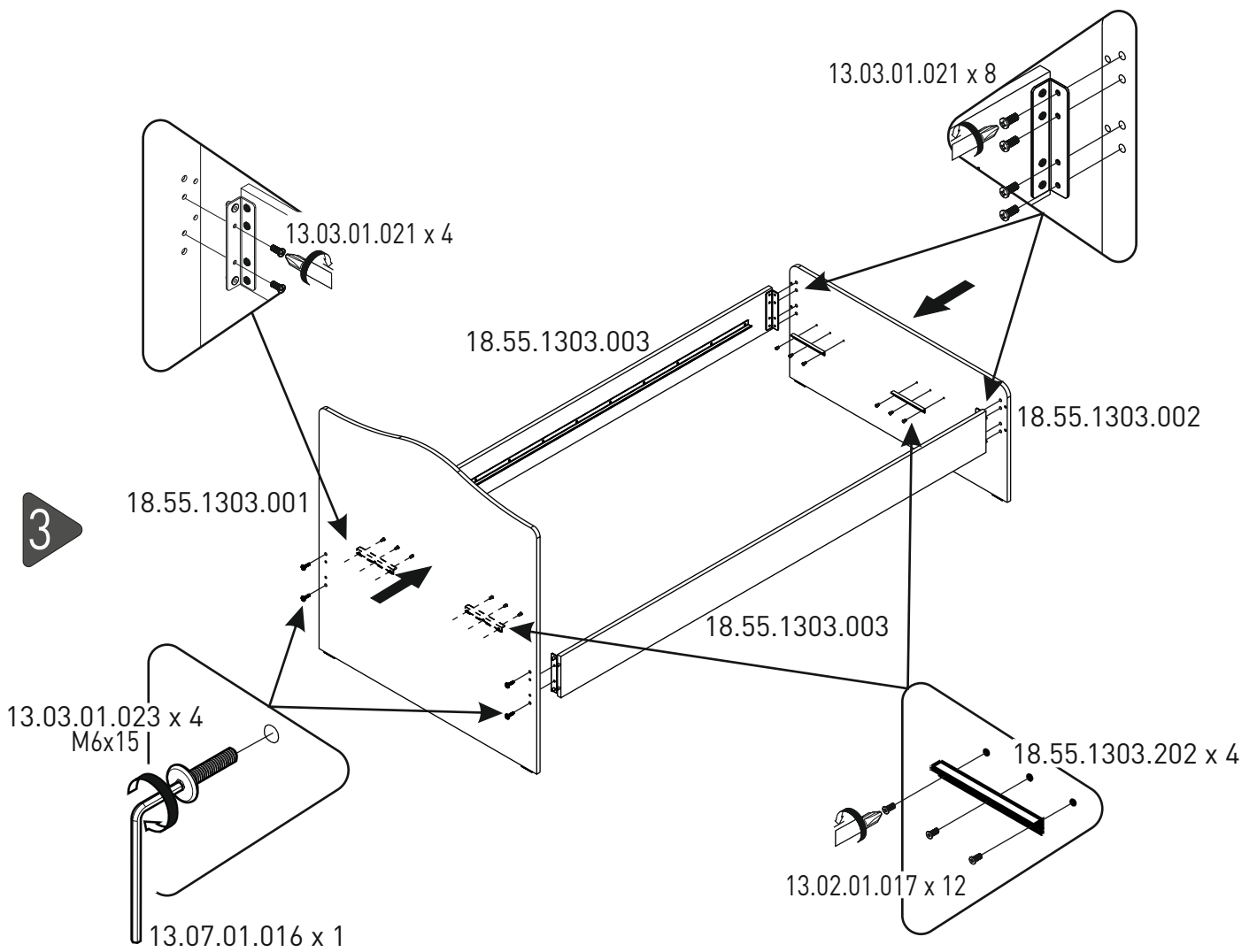

4

