



Инструкция по сборке

NOTE OF ASSEMBLY/NOTICE DE MONTAGE/ MONTAGE-ANLEITUNG

Кодовый № REFERENCE NO. REFERENCE NO. REFERENZ-NR.	CH-4019-WT CH-4019-BK	Белый / White Чёрный / Black
Наименование PRODUCT NAME NOM DU PRODUIT PRODUKTBEZEICHNUNG	COAT RACK / Вешалка напольная TITAN	
EAN:	2099901274458 2099901274441	



	<ol style="list-style-type: none"> 1. Определите детали, из которых состоит ваш предмет. 2. Соберите механические части и пересчитайте их. 3. Убедитесь, что необходимые инструменты готовы к использованию. 4. Организуйте пространство для сборки мебели, пользуйтесь ковровым покрытием или одеялом для защиты мебели от царапин. 5. Не устанавливайте мебель, не убедившись, что все части мебели собраны. <p>ПОСЛЕ НЕКОТОРОГО ПЕРИОДА ЭКСПЛУАТАЦИИ НЕКОТОРЫЕ МЕХАНИЧЕСКИЕ ЧАСТИ МЕБЕЛИ МОГУТ УТРАТИТЬ НАЛАДКУ, ПОЭТОМУ РЕКОМЕНДУЕТСЯ СВОЕВРЕМЕННО ПРОВОДИТЬ РЕГУЛИРОВКУ ВИНТОВ. СОХРАНЯЙТЕ ИНСТРУКЦИЮ ПО СБОРКЕ, ЭТО ПОМОЖЕТ ВАМ, ЕСЛИ НЕКОТОРЫХ МЕХАНИЧЕСКИХ ЧАСТЕЙ НЕ БУДЕТ ХВАТАТЬ.</p>
--	--

	<ol style="list-style-type: none"> 1. Identify the parts which make up your piece of furniture. 2. Gather the hardware parts and count them. 3. Have the necessary tools ready. 4. Organize a space for assembly, wall carpeting or a blanket will protect the furniture against scratches. 5. Mount the furniture, never force the parts to be assembled. <p>TIGHTEN THE SCREWS AFTER IT HAS BEEN USED FOR SOME TIME. KEEP THE ASSEMBLY INSTRUCTION SINCE IT WILL HELP YOU WHEN YOU GET IN TOUCH WITH THE STORE IF A PART SHOULD BE MISSING.</p>
--	--

	<ol style="list-style-type: none"> 1. Repérez les pièces constituant votre meuble. 2. Regroupez et comptez la quincaillerie. 3. Munissez vous de l'outillage nécessaire. 4. Aménagez vous une zone de montage, la moquette ou une couverture protégera des rayures. 5. Procédez au montage, ne jamais forcer sur les assemblages, resserez les vis après quelques temps d'usage. <p>GARDEZ VOTRE NOTICE DE MONTAGE SI UNE PIÈCE VENAIT À MANQUER ELLE SERA LE MOYEN LE PLUS CLAIR POUR COMMUNIQUER AVEC VOTRE MAGASIN.</p>
--	---

	<ol style="list-style-type: none"> 1. Bitte überprüfen Sie, ob alle Einzelteile Ihres Möbelstücks vorhanden sind. 2. Bitte überprüfen Sie, ob alle Schrauben und Verbindungsteile für die Montage vorhanden sind. 3. Halten Sie alle notwendigen Montage-Werkzeuge für ihren Einsatz gebrauchsbereit. 4. Bereiten Sie einen passenden Ort für die Montage vor. Ein Teppichboden oder ähnliches schützt vor Kratzern. 5. Beginnen Sie mit der Montage. Lassen Sie sich Zeit und fügen Sie die Einzelteile nie mit Gewalt zusammen. <p>Um einen langfristigen und einwandfreien Gebrauch zu gewährleisten, ziehen Sie die einzelnen Schrauben regelmäßig nach längerer Nutzung des Möbelstücks fest. Bitte bewahren Sie diese Montageanleitung auf. Diese gewährleistet im Problemfall einen reibungslosen und schnellen Kommunikationsaustausch mit dem Kundenservice Ihres Geschäfts.</p>
--	--

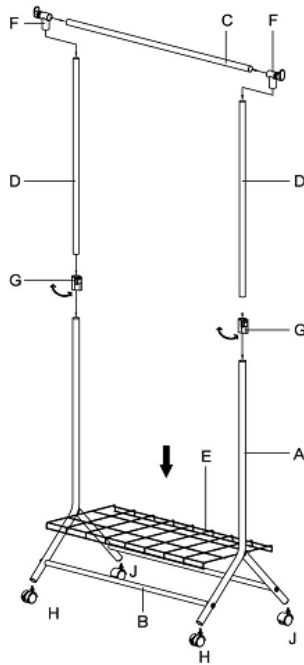

No.	Размер	Кол-во	№ кор.
No.	Size	Qty	Ctn no.
No.	Taille	Qté	Ctn no.
Nr.	Maße	Anzahl	Ktn nr.
A	985x445x25mm	2	1
B	850x16mm	2	1
C	960x22mm	1	1
D	770x22mm	2	1
E	840x360x24mm	1	1
F	58.5x65x25mm	2	1
G	35x49x35mm	2	1

No.	Размер	Кол-во	№ кор.
No.	Size	Qty	Ctn no.
No.	Taille	Qté	Ctn no.
Nr.	Maße	Anzahl	Ktn nr.
H	40x40x35mm	2	1
I	37x10.5mm	4	1
J	40x30mm	2	1
K	16x1mm	4	1
L	35x25mm	4	1

Фурнитура/Hardware/Quincailleries/ Montageteile- Ctn no./Kto. nr.

1

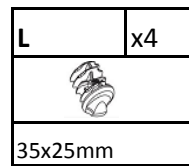
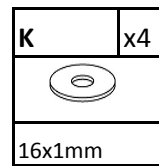
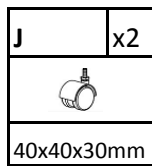
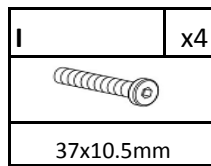
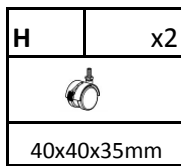
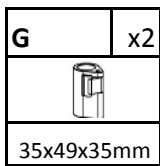
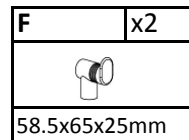
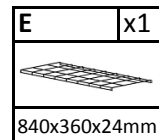
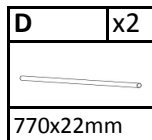
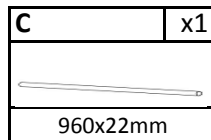
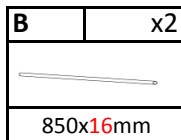
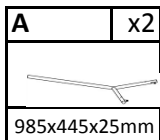

ВРЕМЯ СБОРКИ: 10 МИНУТ
SET-UP TIME: 10 MINUTE
TEMPS DE MONTAGE: 10 MINUTE
MONTAGEZEIT: 10 MINUTEN



ИНСТРУМЕНТЫ:
TOOLS:
OUTILLAGE:
WERKZEUGE:



КОЛИЧЕСТВО ЧЕЛОВЕК: 01
NUMBER OF PERSONS: 01
NOMBRE DE PERSONNES: 01
NOTWENDIGE PERSONEN: 01



ДЛЯ УХОДА ЗА ИЗДЕЛИЕМ ДОСТАТОЧНО БУДЕТ ПРИМЕНЕНИЯ ТРЯПКИ
FOR GENERAL CARE, A PIECE OF CLOTH WILL BE ENOUGH.
POUR L'ENTRETIEN, UN CHIFFON DOUX SUFFIRA.
HALTEN SIE FÜR EINE SAUBERE MONTAGE EIN FEUCHTES TUCH BEREIT.

SAV / Spareparts / Запасные части / Einzelteile

EAN

(No. / Nr/№) x (Qté/Qty/Кол-во/Anzahl)

x	x	x	x
x	x	x	x
x	x	x	x

1

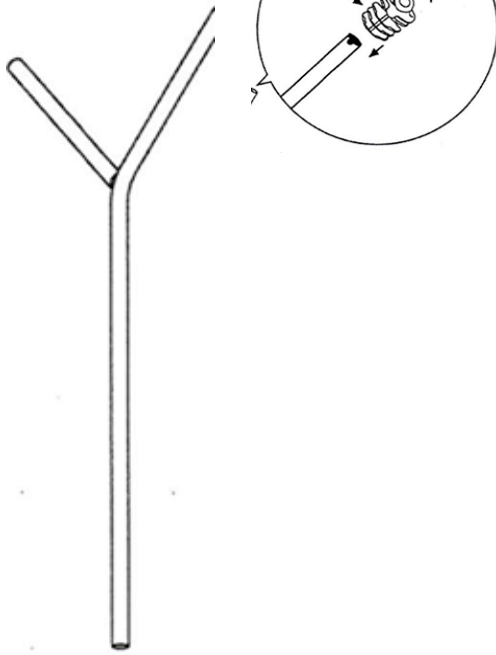

H	x 2	J	x 2	L	x 4
40x40x35mm		40x40x30mm		35x25mm	

2

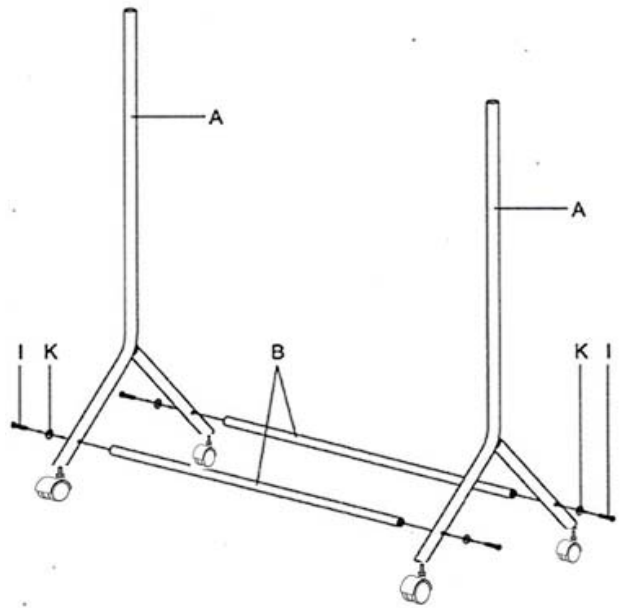

I	x 4	K	x 4
37x10.5mm		16x1mm	

3

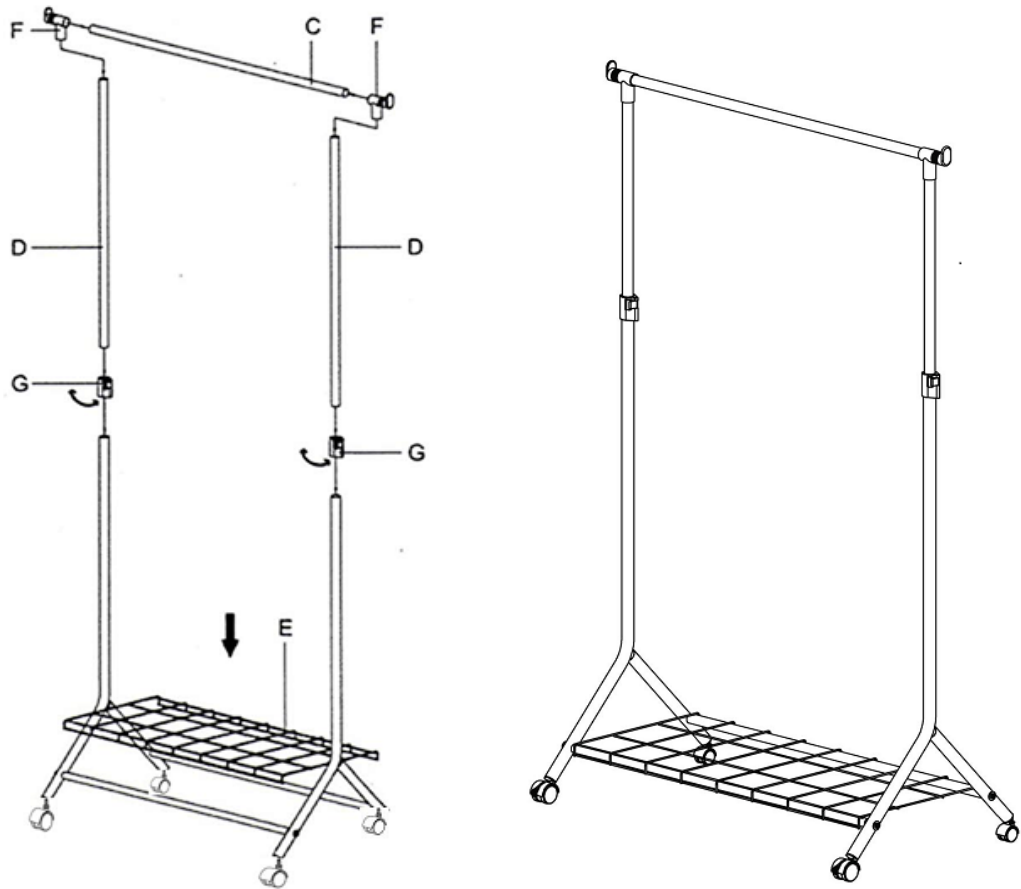

F	x 2	G	x 2
58.5x65x25mm		35x49x35mm	