



ЛЮБИМЫЙ
МЕБЕЛЬ **ДОМ**



LUBIDOM
furniture

EAC

Модерн
ЛД.520010.000 - Кровать двухъярусная

Modern

LD.520010.000 - Double-bunk bed case

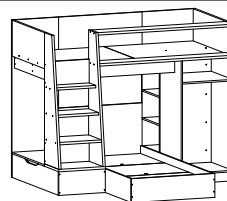

	2065
	1660
	2045

A x22	B x22	C x62	D x30	E x28	F x76	G x1	H x6	I x14	J x87
K x4	L x140	M x5	N x42	O x4	P x24	Q x1	R x15	S x4	T x3
U x4	V x2	W x4	X x2	Y x1	Z x4				

	1h 40min		600mm	0.5kg	3m			

①	520010.001	1	2	⑩	520010.020	1	1	
②	520010.002	1	2	⑪	520010.021	2	4	
③	520010.003	2	2	⑫	520010.022	2	2	
④	520010.004	2	2	⑬	520010.023	1	3	
⑤	520010.005	1	3	⑭	520010.024	1	6	
⑥	520010.006	1	3	⑮	520010.025	1	7	
⑦	520010.007	4	8	⑯	520010.026	1	7	
⑧	520010.008	1	3	⑰	520010.027	1	7	
⑨	520010.009	1	2	⑱	520010.028	1	6	
⑩	520010.010	1	3	⑲	520010.029	1	3	
⑪	520010.011	1	2	⑳	520010.030	1	6	
⑫	520010.012	1	2	㉑	520010.031	1	6	
⑬	520010.013	1	2	㉒	520011.001	1	5	
⑭	520010.014	1	3	㉓	520011.002	1	4	
⑮	520010.015	1	2	㉔	520011.003	2	4	
⑯	520010.016	1	1	㉕	520011.004	3	5	
⑰	520010.017	1	1	㉖	520011.005	2	4	
⑱	520010.018	1	6	㉗	520011.006	4	5	
⑲	520010.019	1	6					

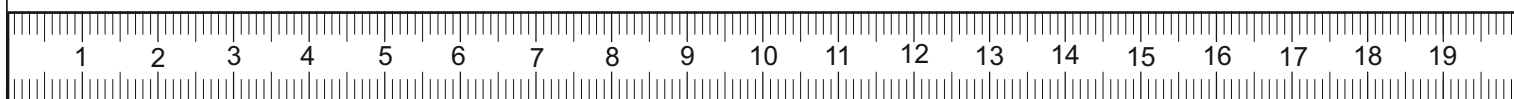

*Опция(Option)

ЛД.519010.000/LD.519010.000

ДМ «Бэтмен» Фасад Кровати двухъярусной \
DM «Batman» Facade bunk bed

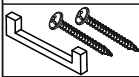
39	519010.001	1	1/1
40	519010.002	1	
			
a	x1		

*Опция(Option)

ЛД.518010.000/LD.518010.000

ДМ «Футбол» Фасад Кровати двухъярусной \
DM «Football» Facade Double-bunk bed

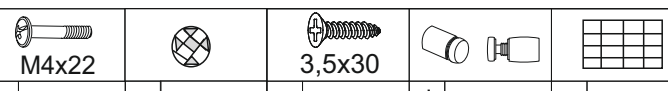
41	518010.001	1							
42	518160.002	1							
									
a	x1	b	x1	c	x4	d	x4	e	x1

*Опция(Option)

ЛД.520140.000/LD.520140.000

ДМ «Модерн»Комплект накладок для ступеней \
DM «Modern»Cover set for steps

43	520140.001	4
----	------------	---







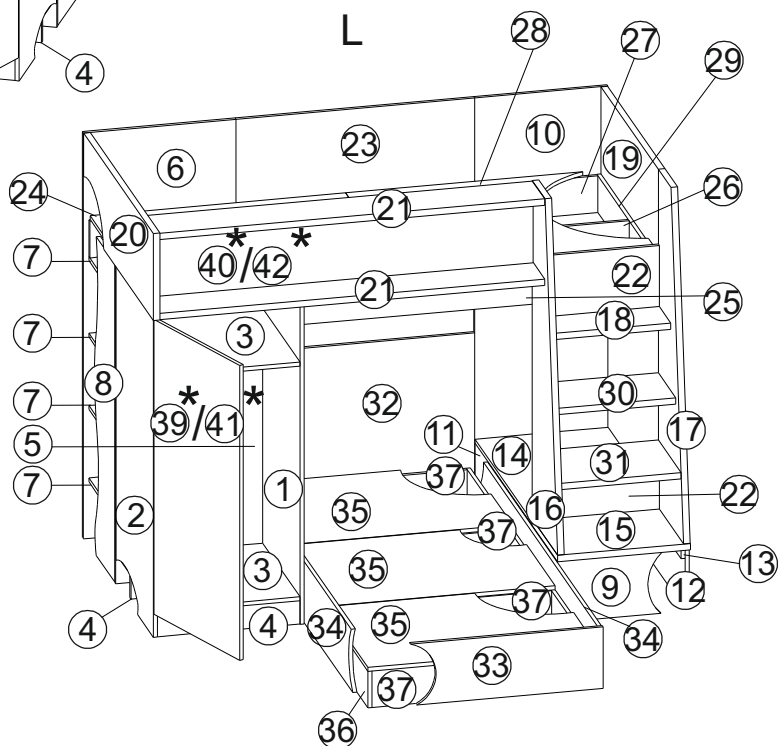
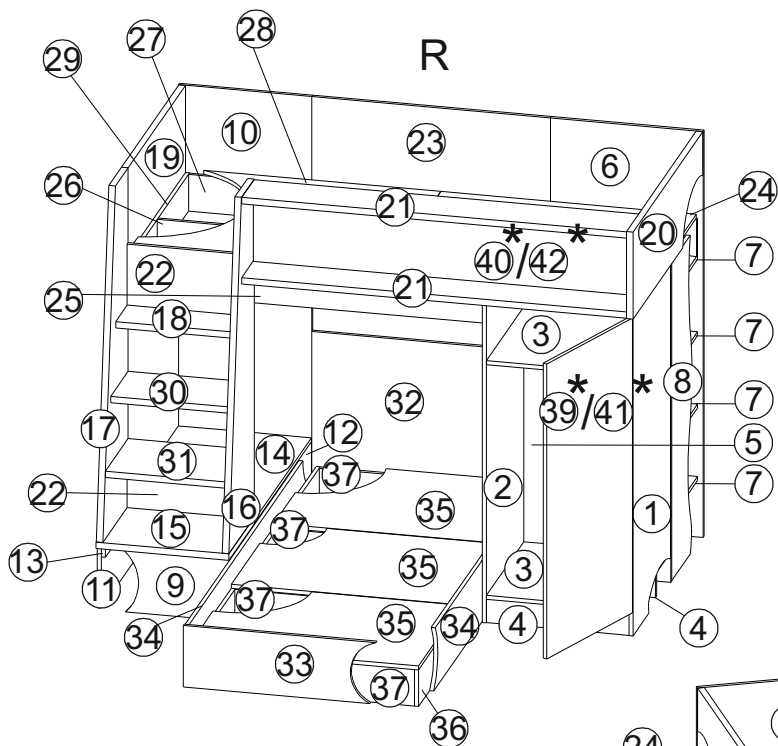

*Опция(Option)

ЛД.518150.000/LD.518150.000

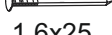
ДМ «Футбол» спинка мягкая \
DM «Football» Headboard soft

44	518150.000	1			
					
a	x4	b	x4	c	x4



					
A x10	B x8	C x16	D x8	E x16	L x10
					
M x3	X x2				

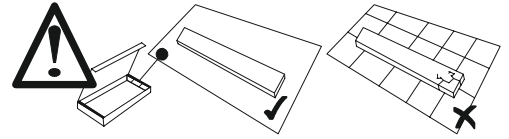

R

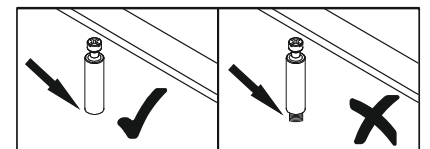
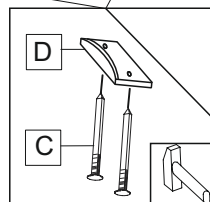
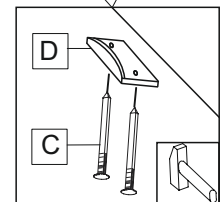
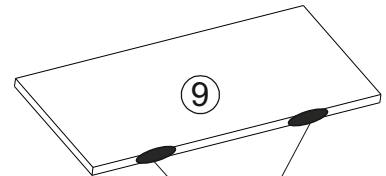
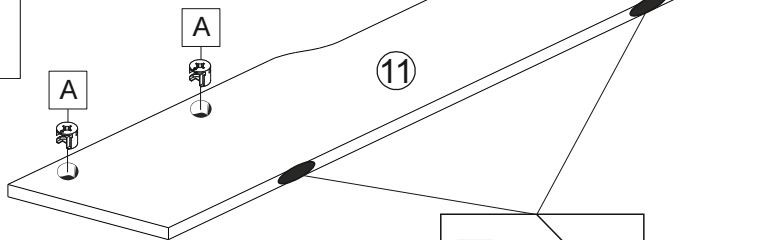
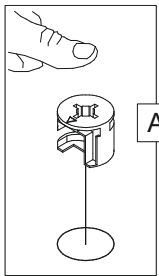
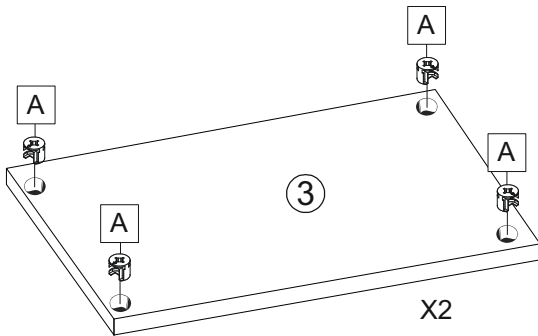
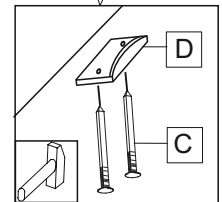
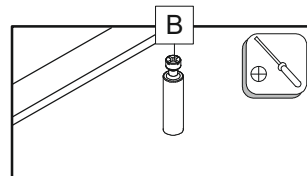
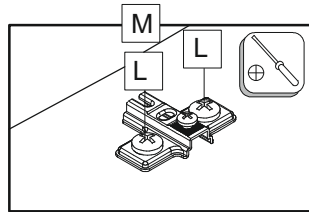
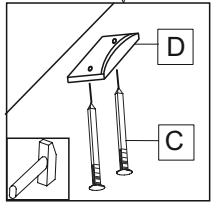
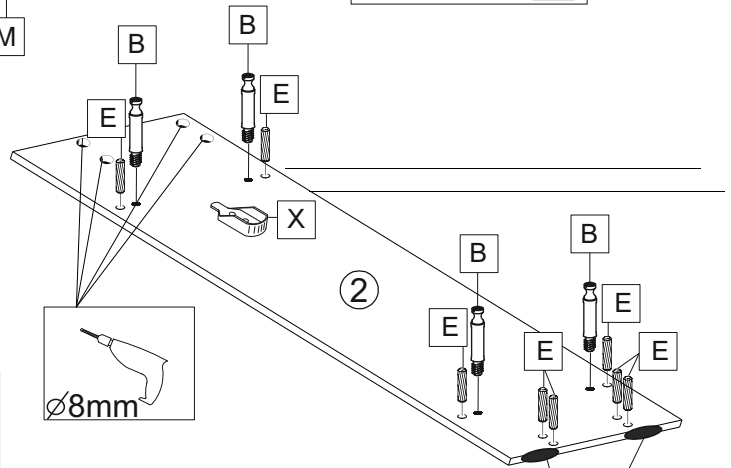
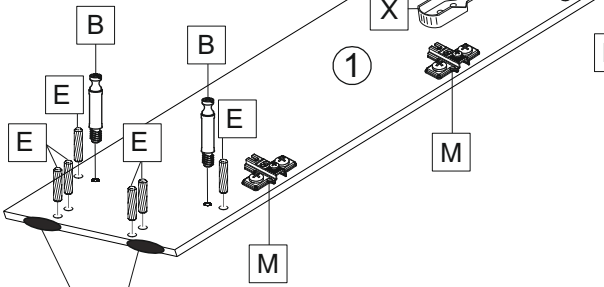
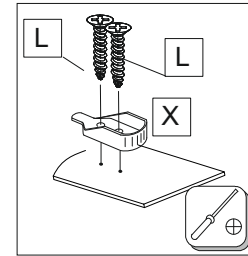
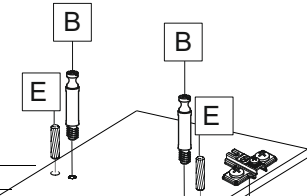
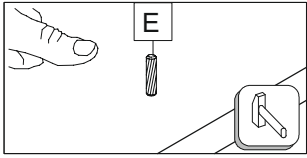

A	B	1,6x25	D	E	3,5x16
x2	x14	x20	x10	x4	x4
		8x50			
M	O	x3			

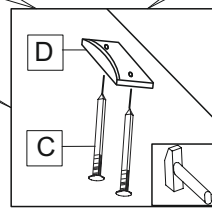
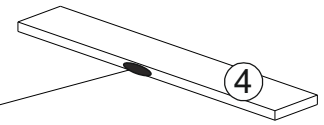
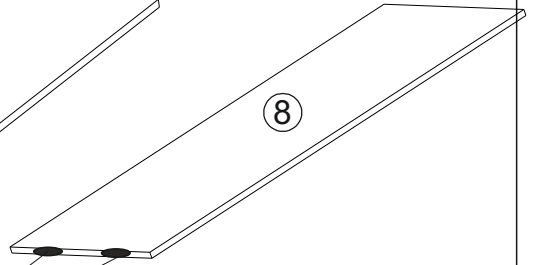
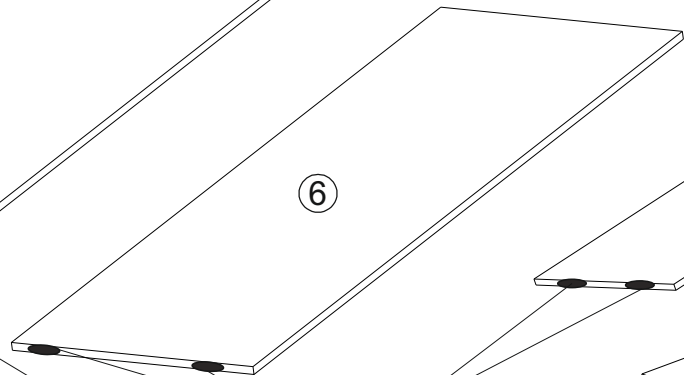
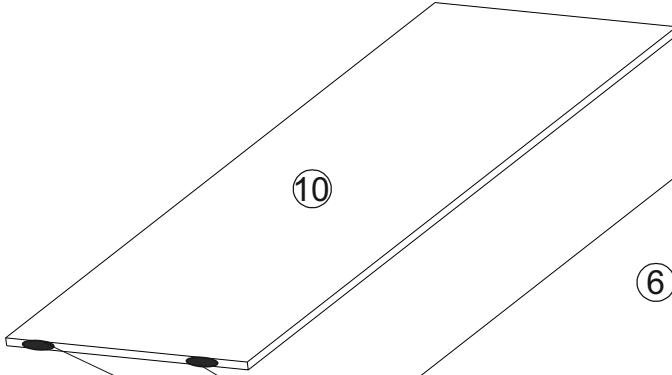
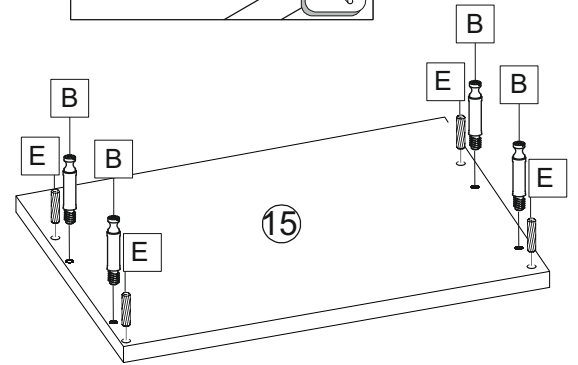
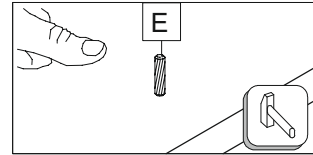
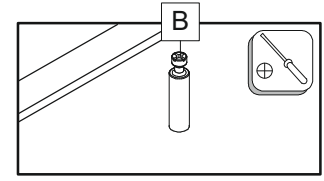
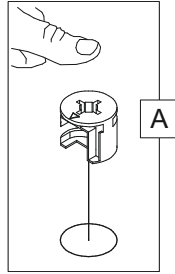
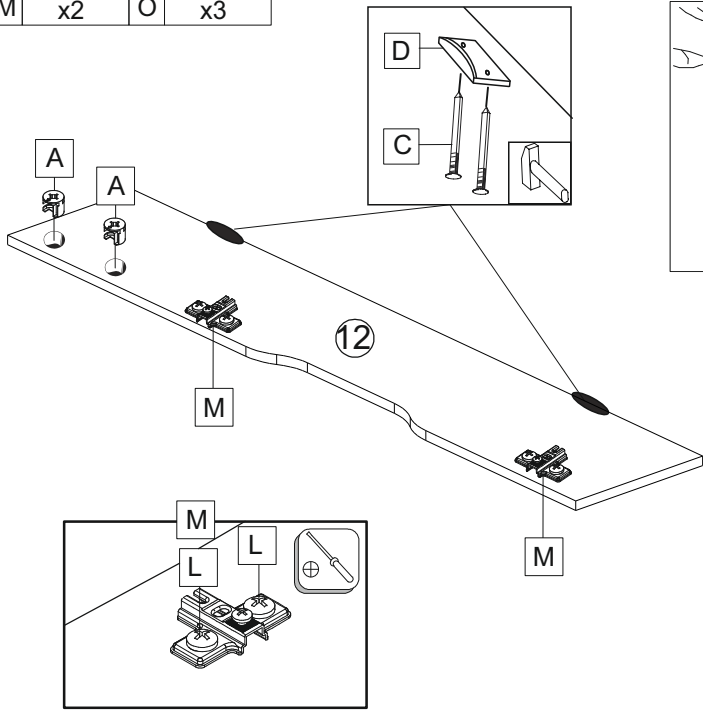
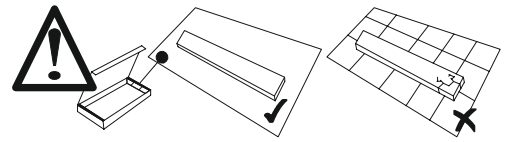

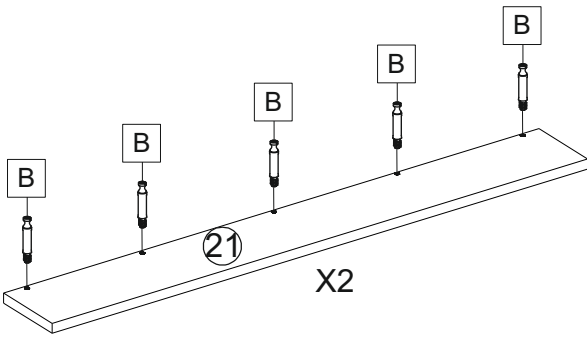

X2

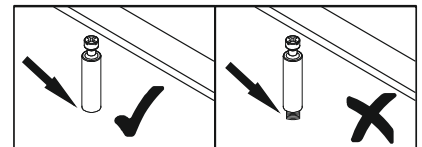

X2





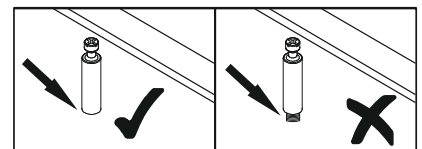
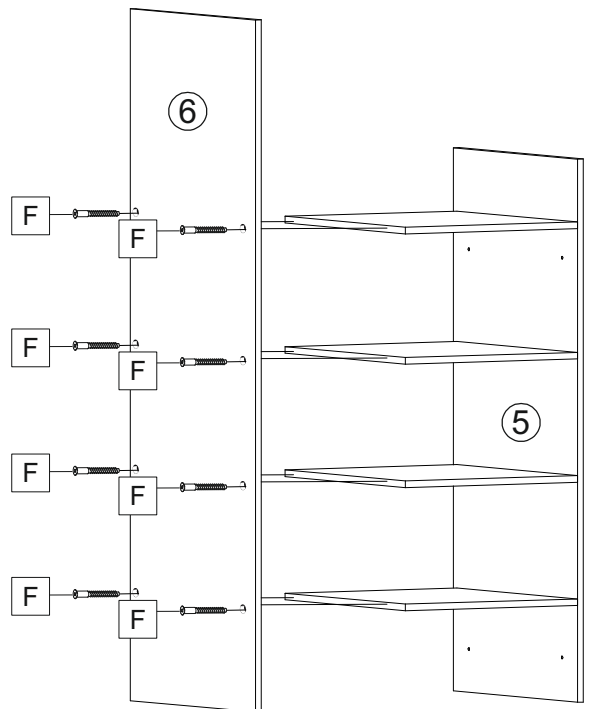
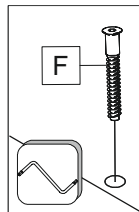
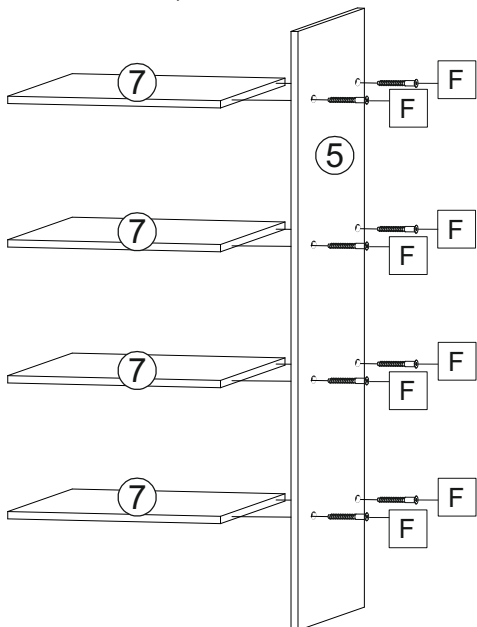
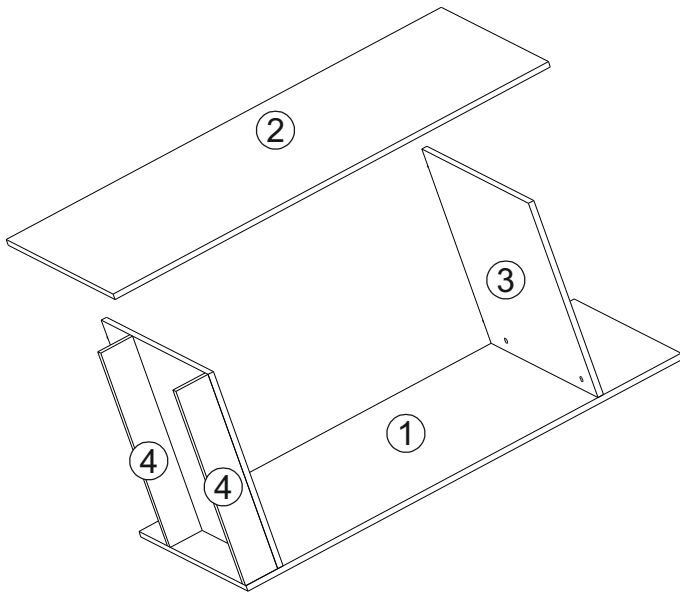
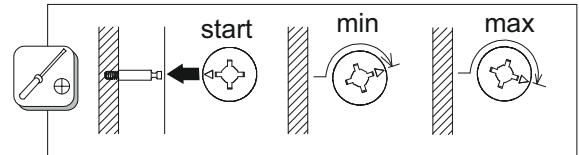
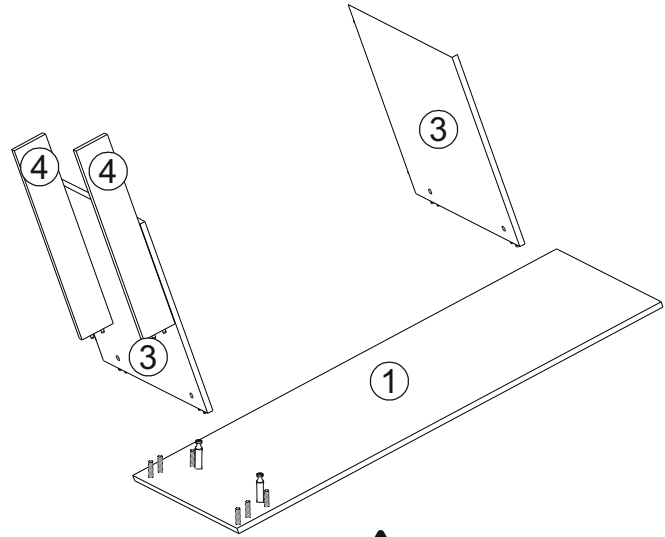
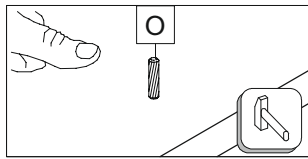
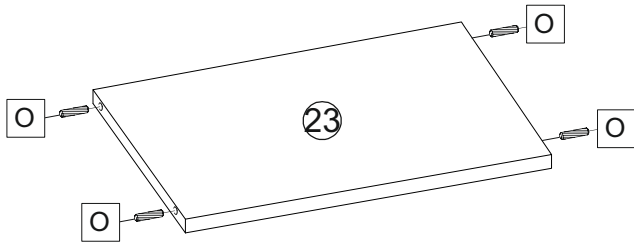
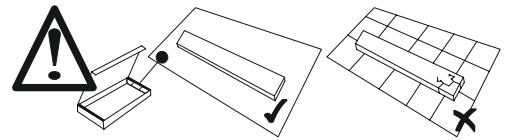

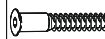
8x50			
		7x50	
O	x4	F	x16

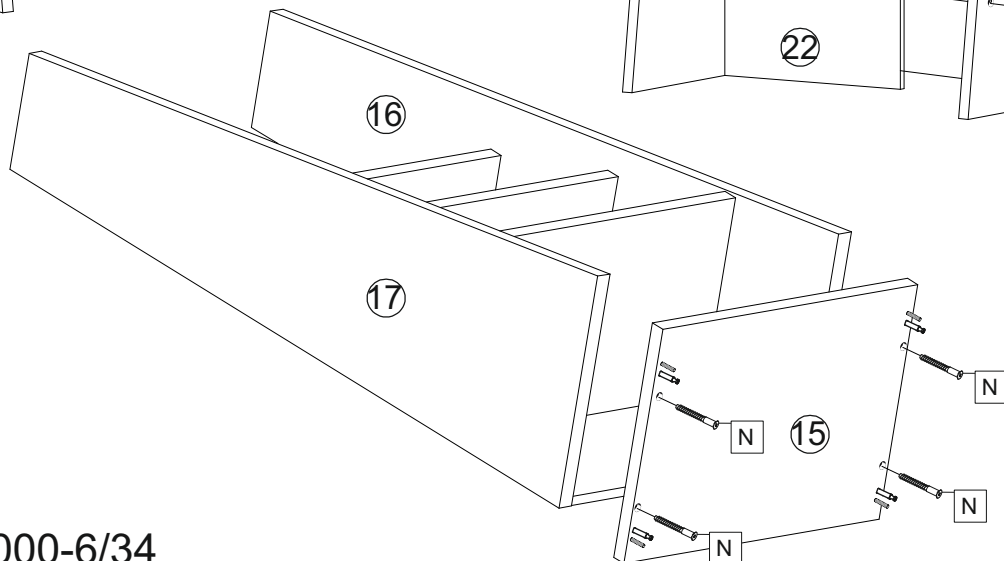
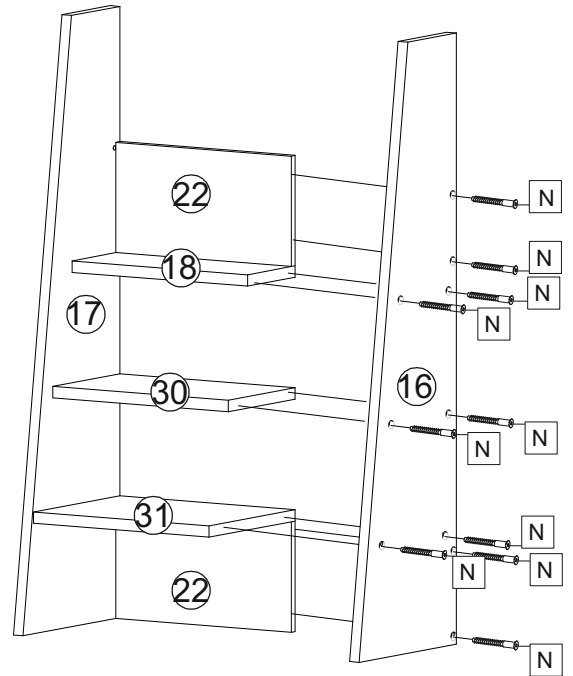
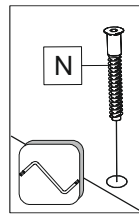
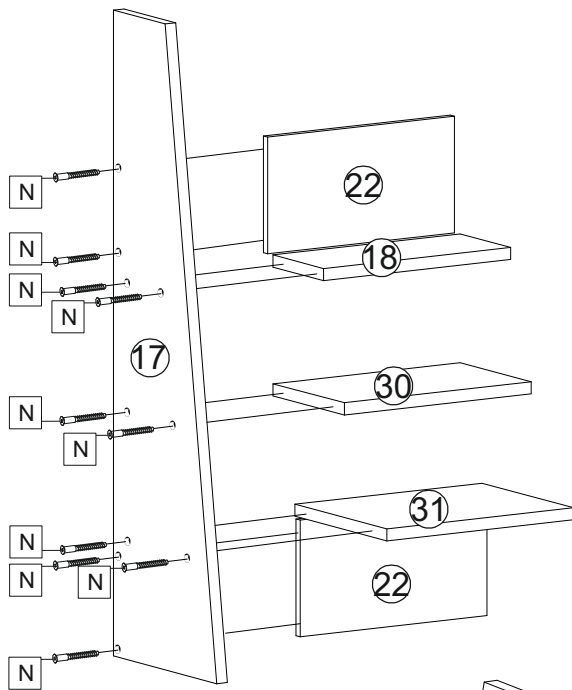
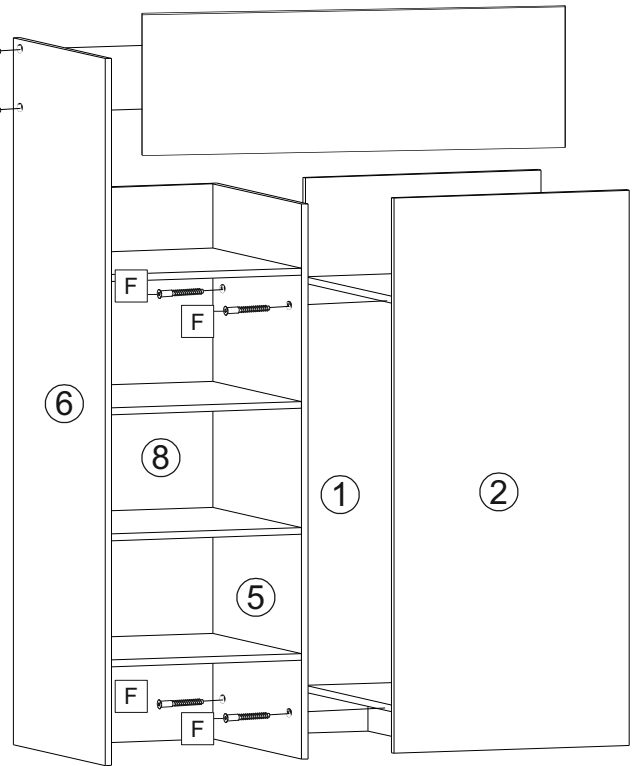
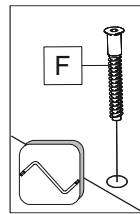
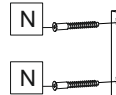
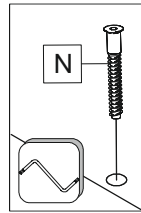
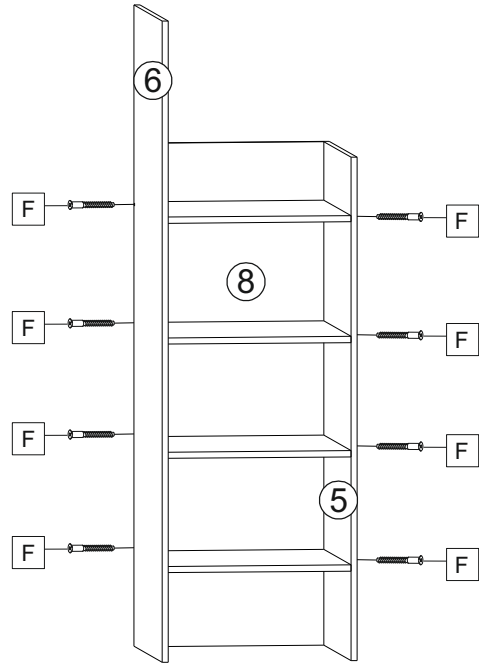
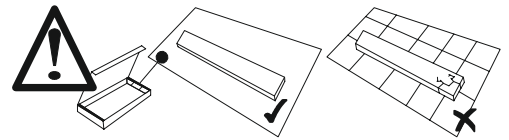

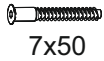

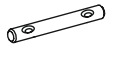

	
7x50	7x70
F x12	N x26

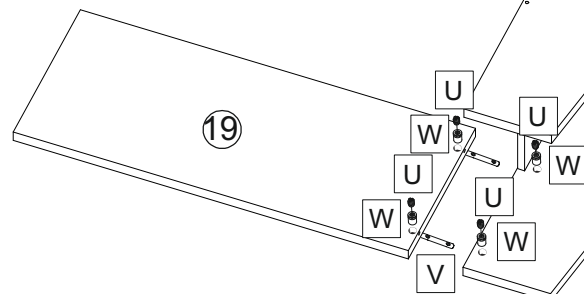
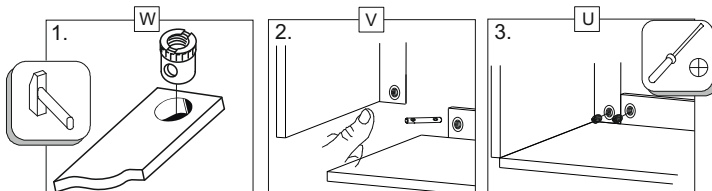
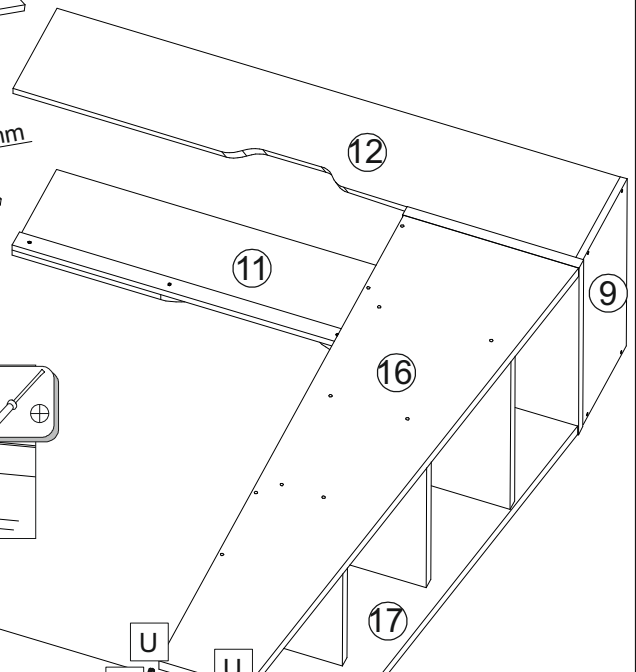
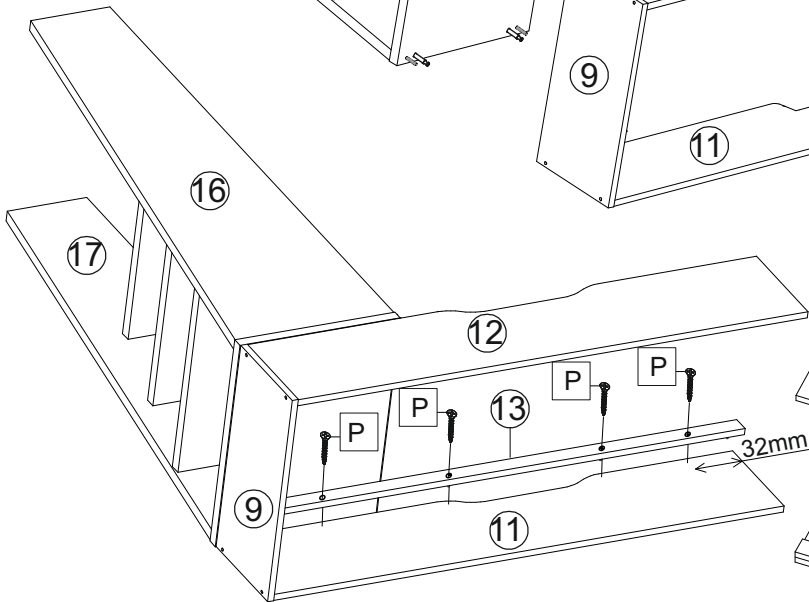
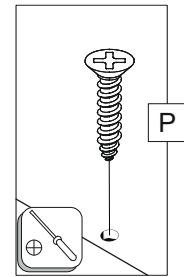
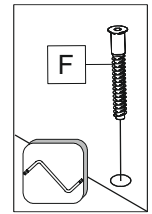
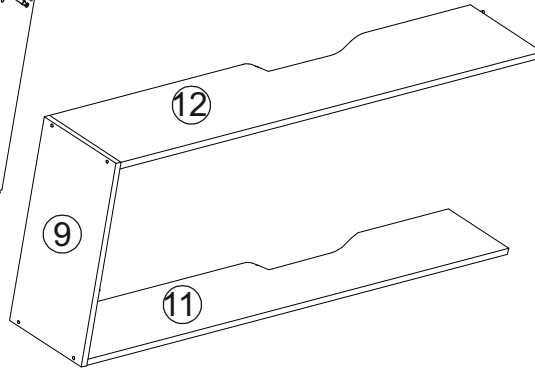
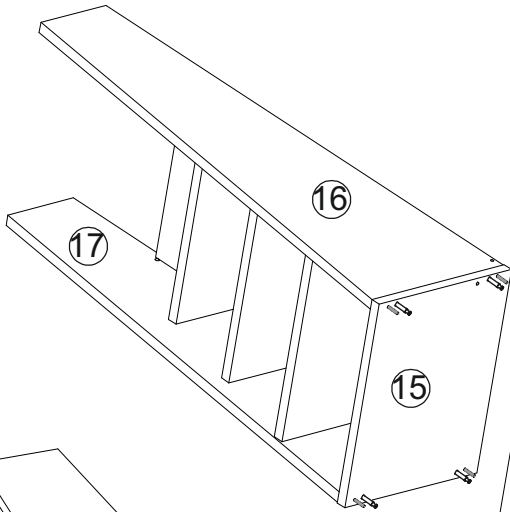
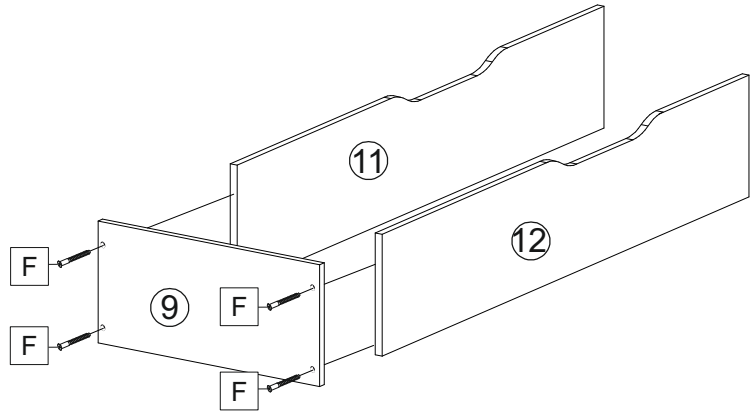
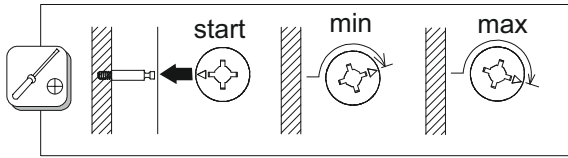
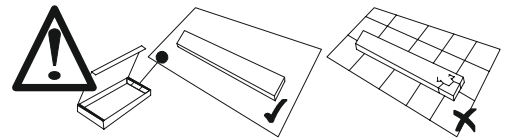

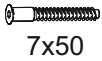

				
7x50	3,5x30			
F x4	P x4	U x4	V x2	W x4

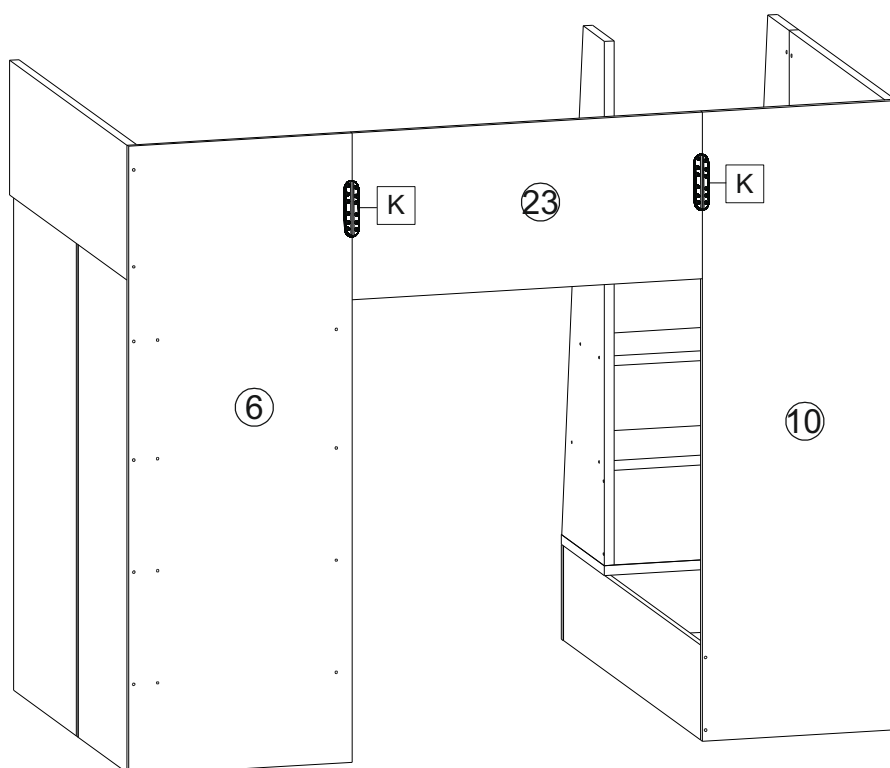
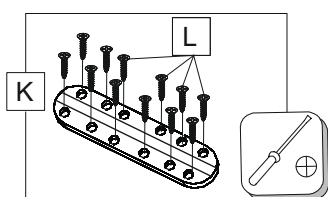
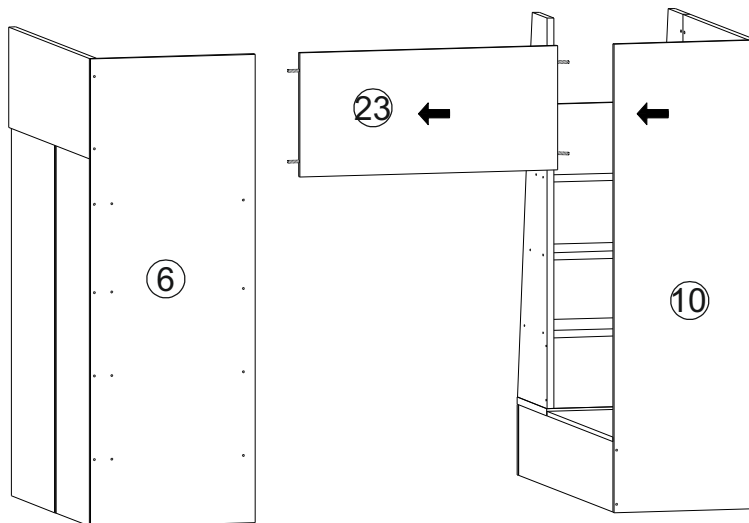
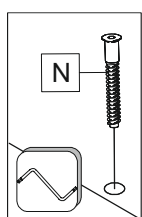
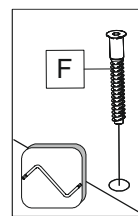
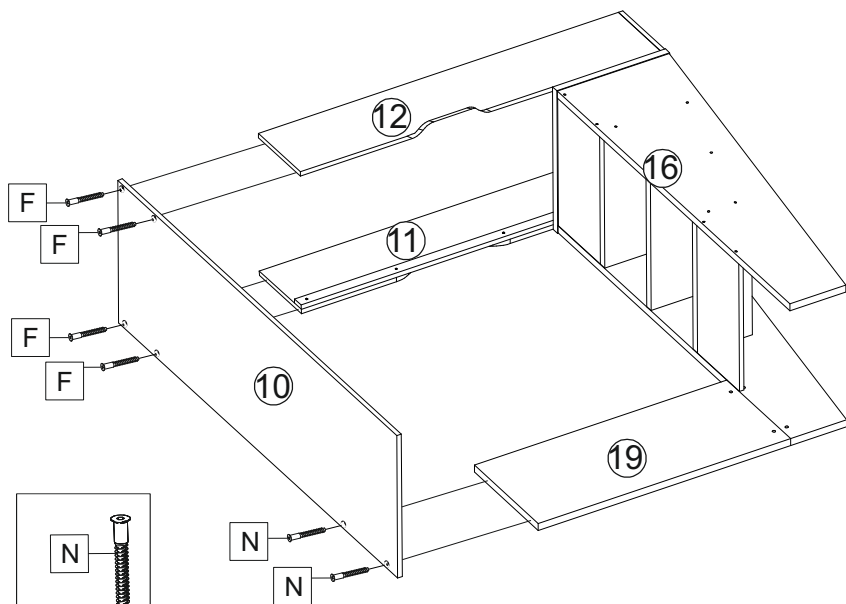
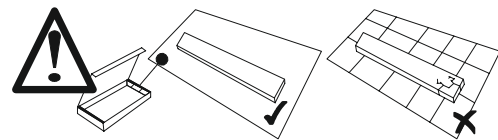

			
F x4	K x2	L x24	N x2





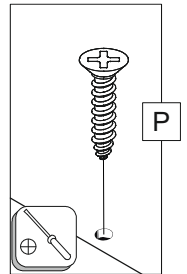
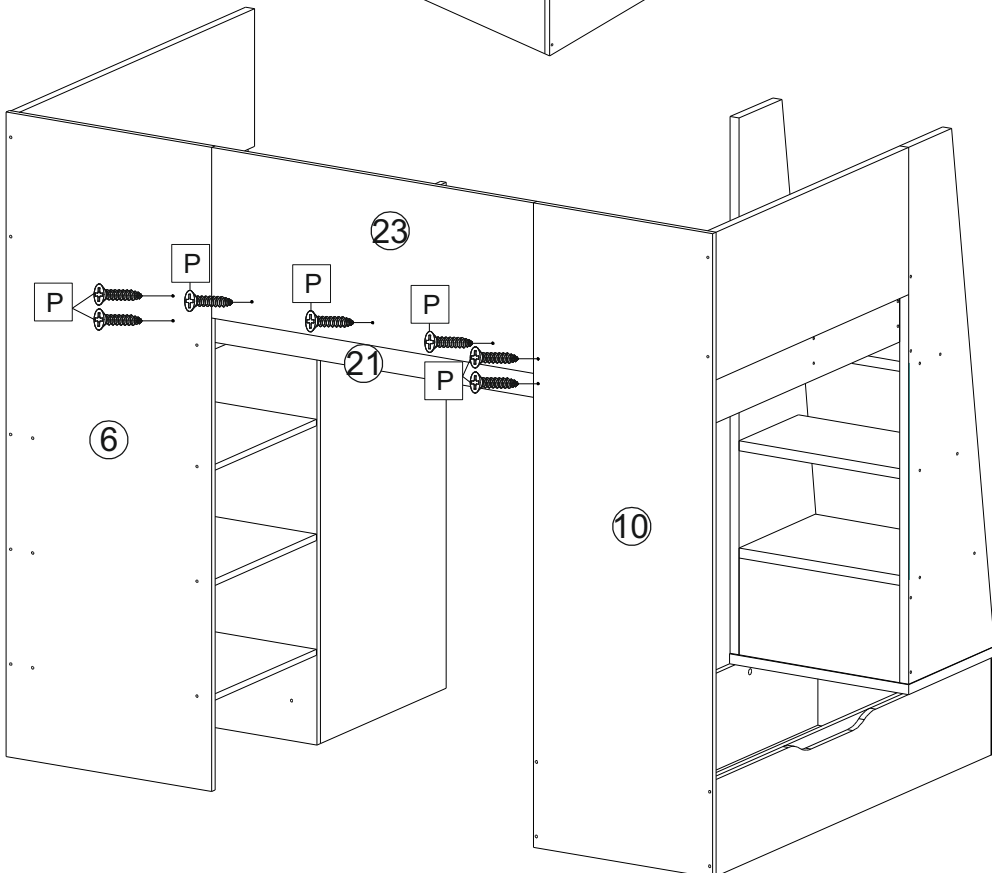
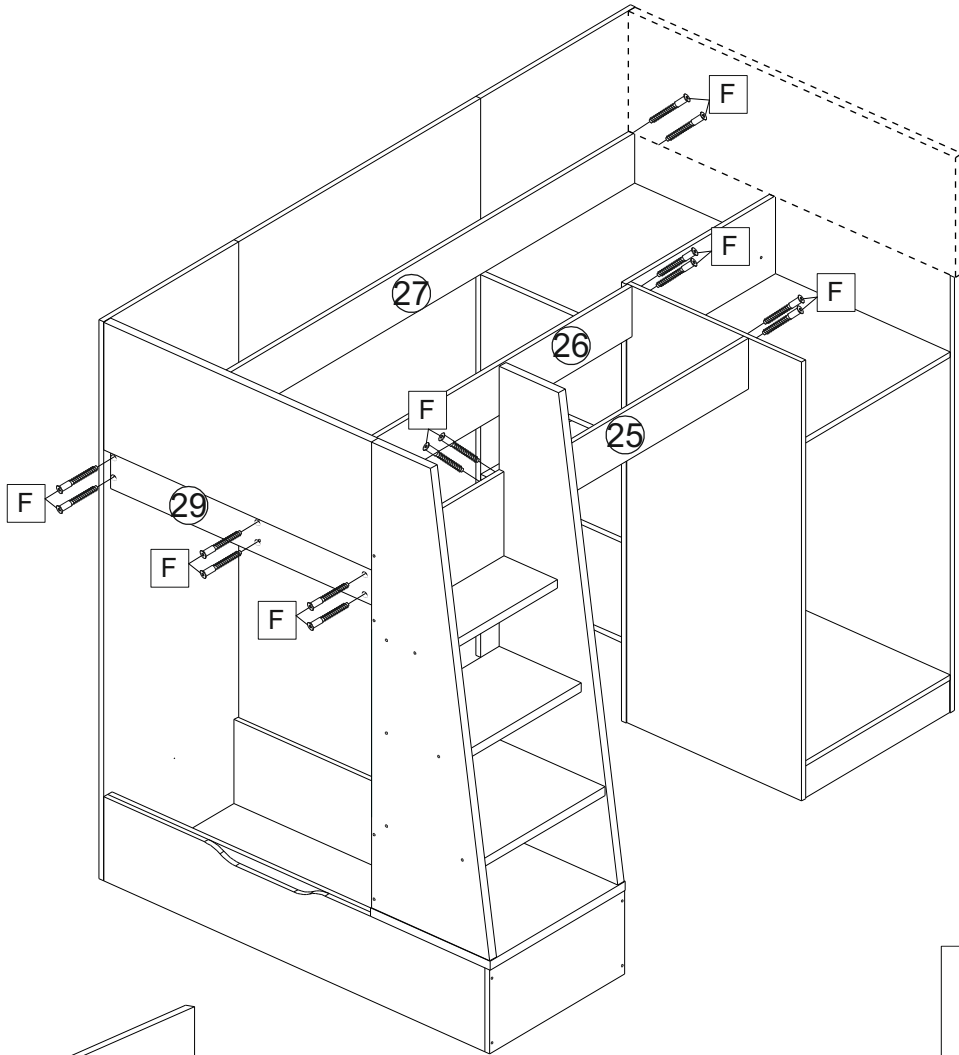
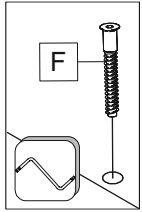
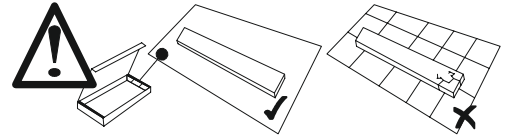

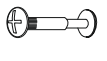
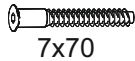
	
7x50	3,5x30
F x14	P x7

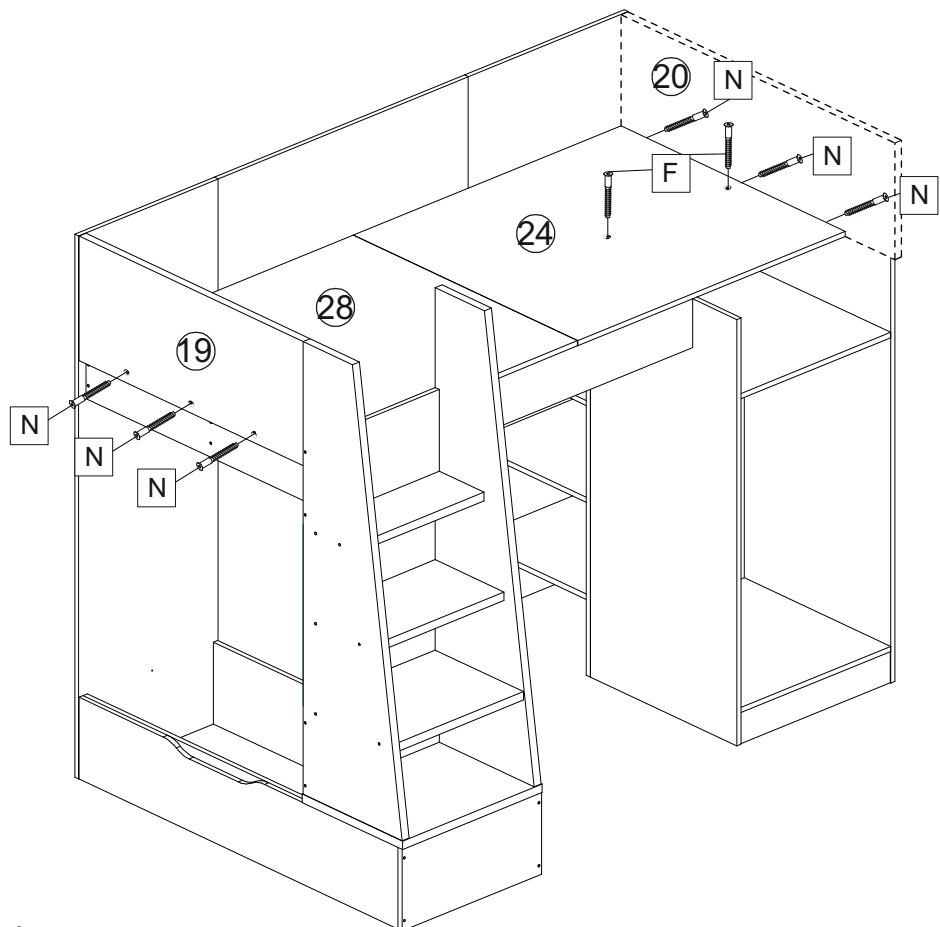
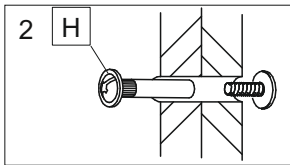
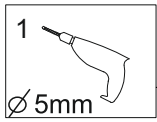
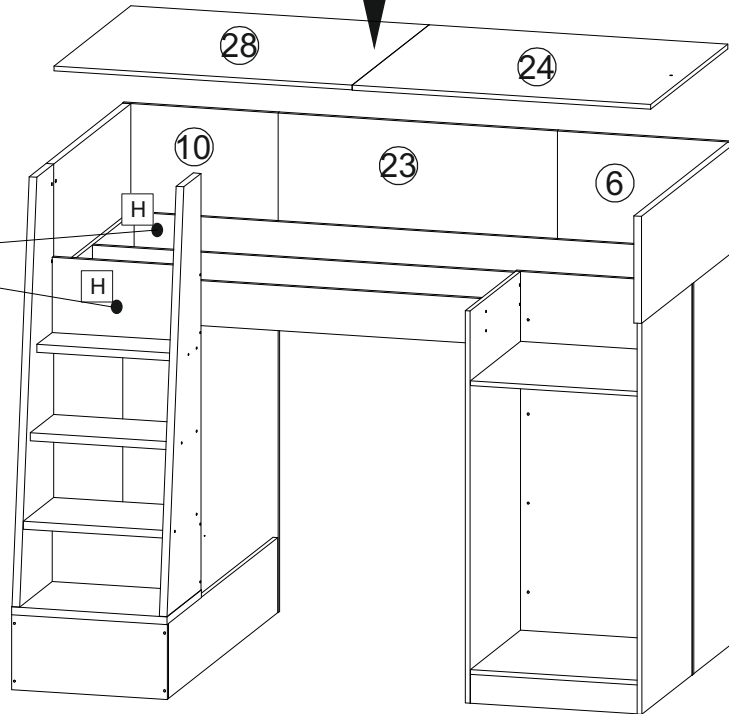
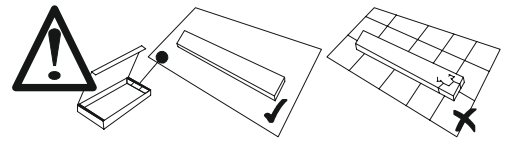

		
7x50	7x70	7x70
F x2	H x2	N x6



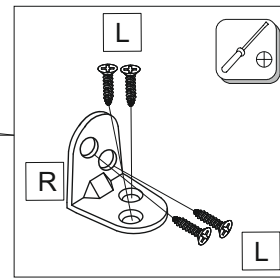
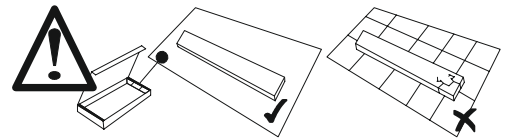
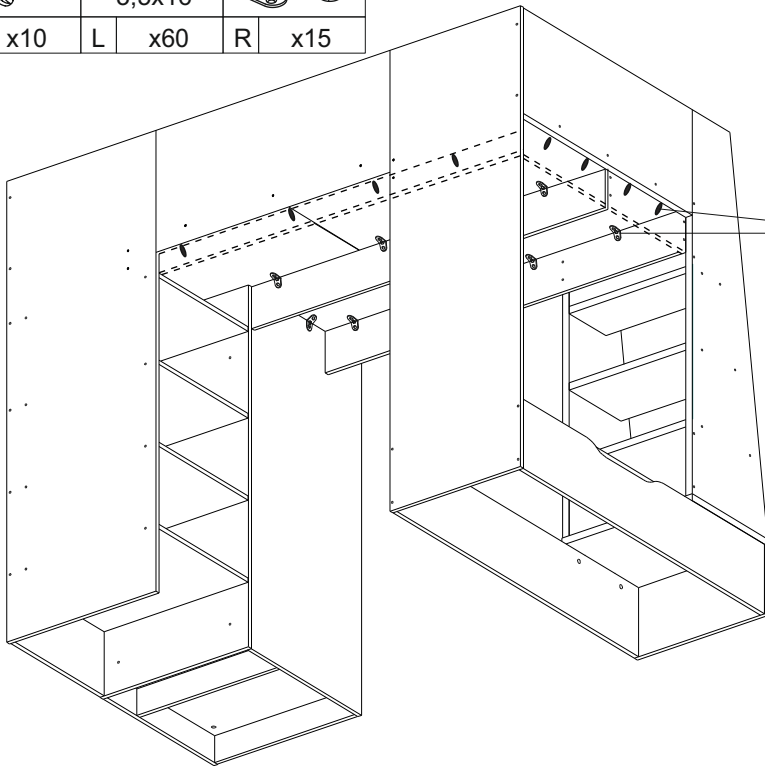

			
A	3,5x16	L	R
x10	x60	x60	x15



***Опция(Option)**

ЛД.519010.000/LD.519010.000

ДМ «Бэтмен» Фасад Кровати двухъярусной \
DM «Batman» Facade bunk bed

	 519010.002	1
---	--	---

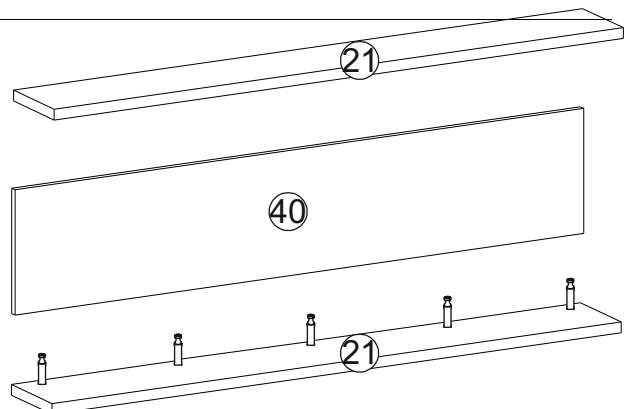
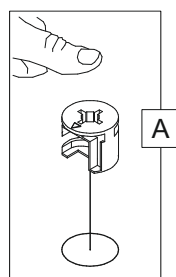
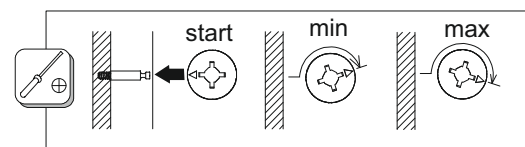
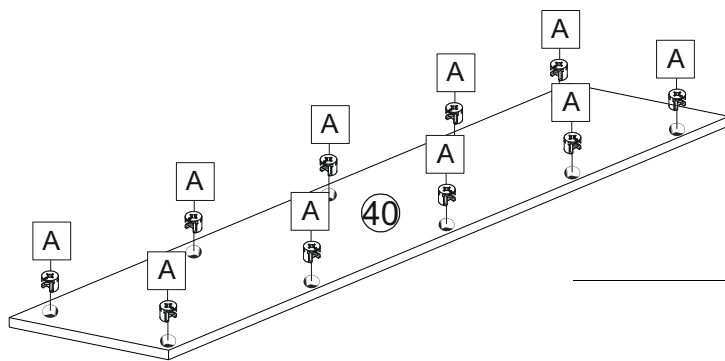

LD.520010.000-11/34

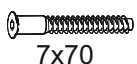

7x70

A x10

N x8

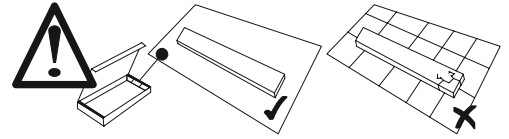

*Опция(Option)



ЛД.518010.000/LD.518010.000

ДМ «Футбол» Фасад Кровати двухъярусной \
DM «Football» Fasade Double-bunk bed



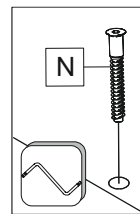
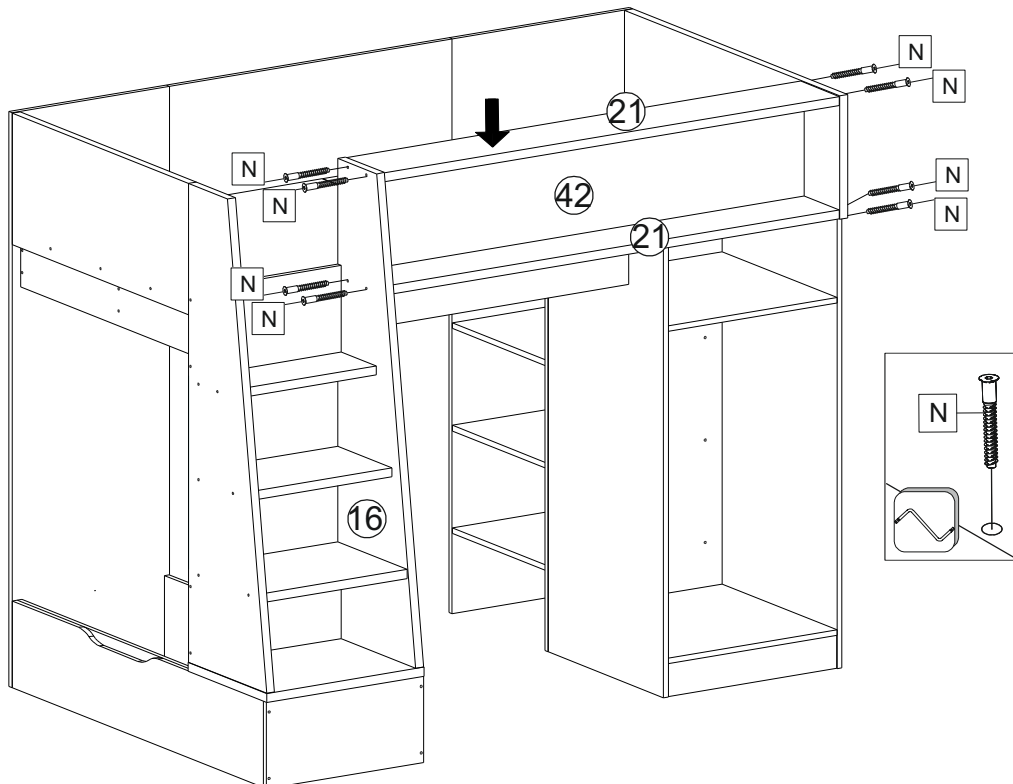
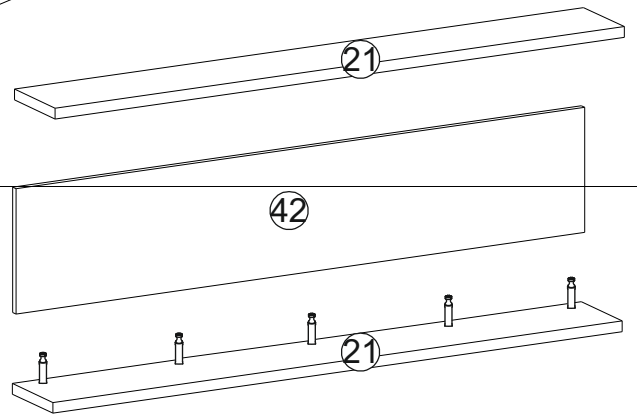
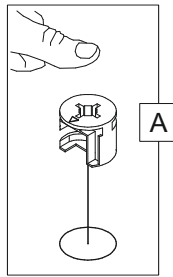
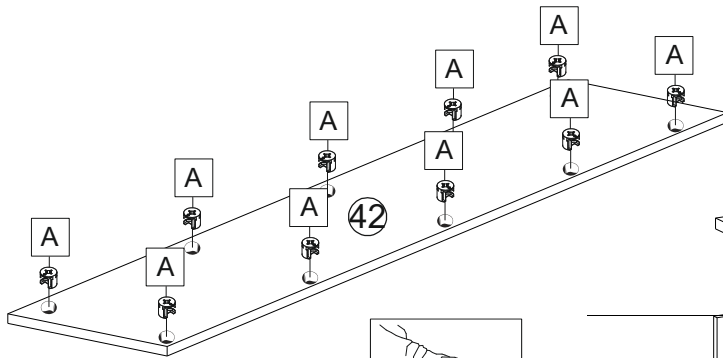

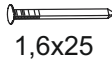
④ 518010.002 1

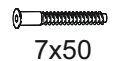

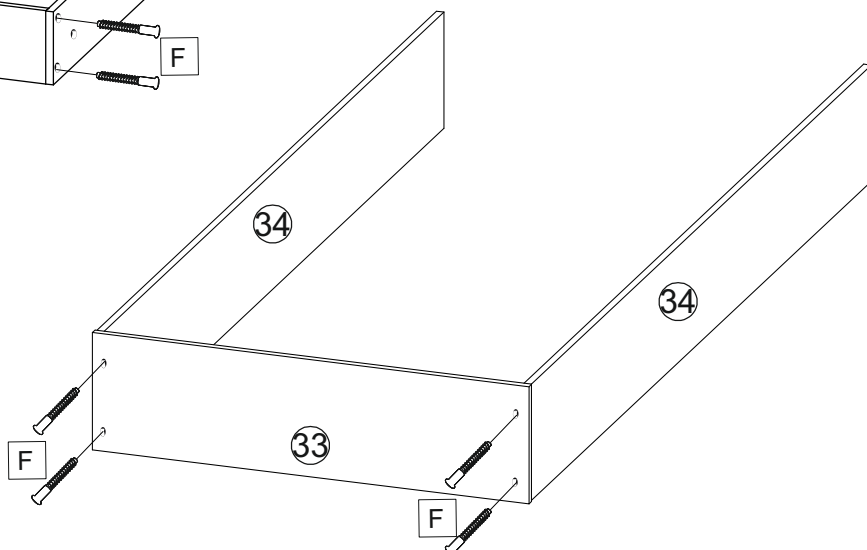
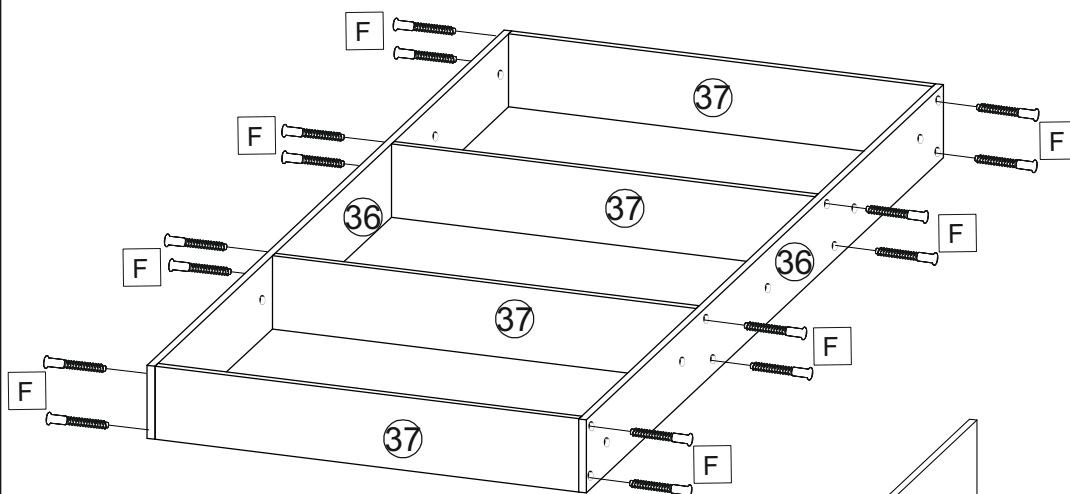
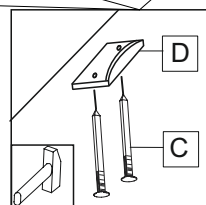
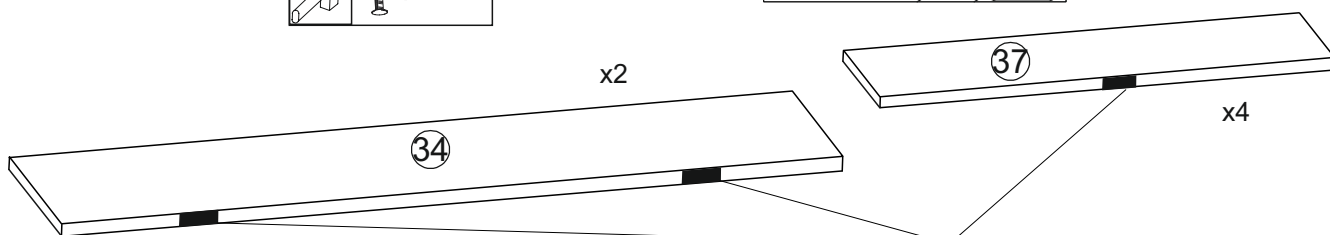
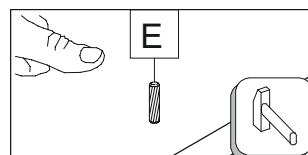
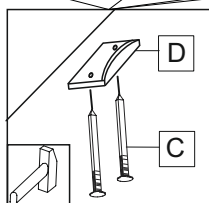
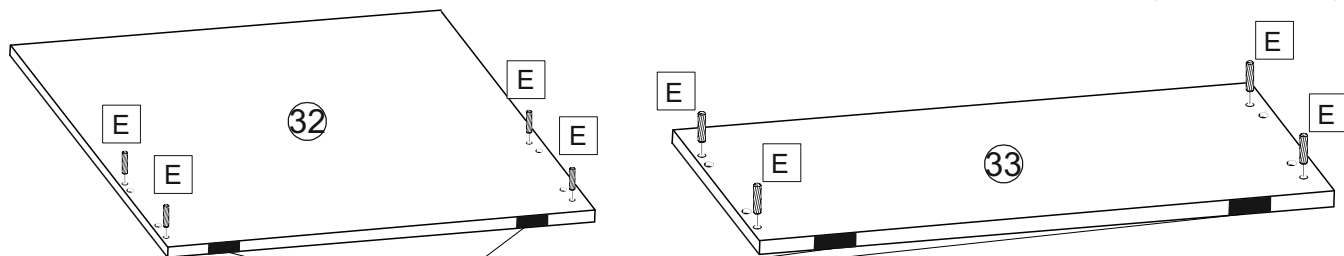
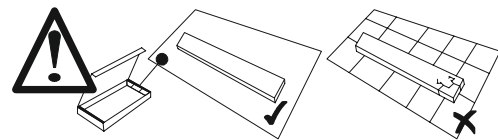



			
8x30	1,6x25		7x50
E x8	C x24	D x12	F x20

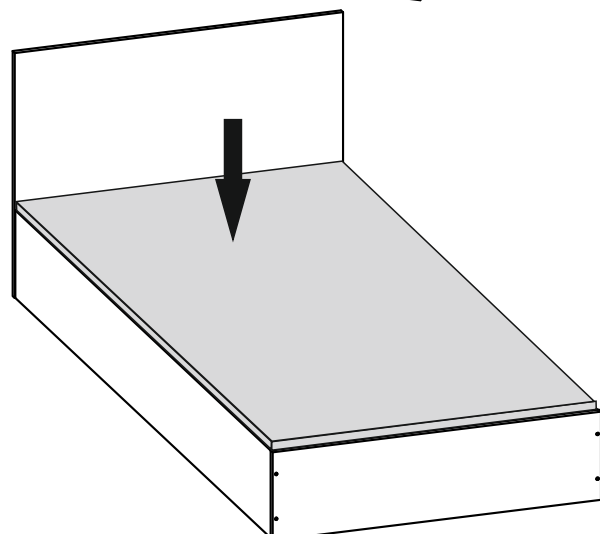
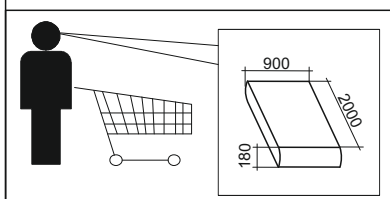
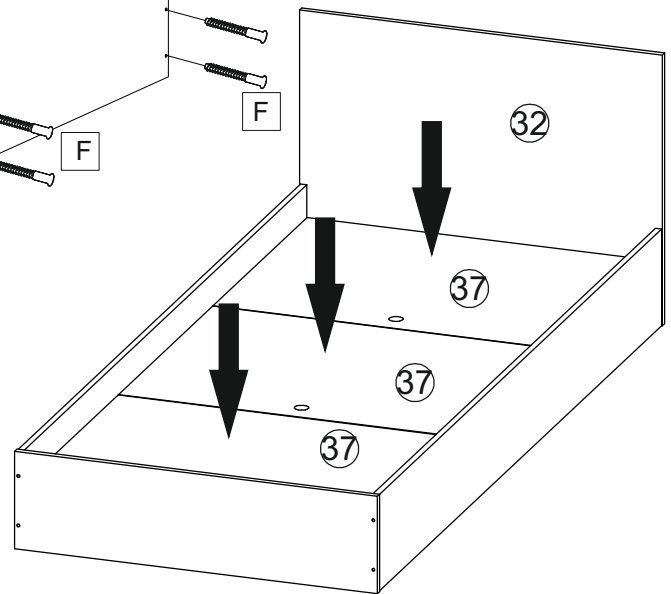
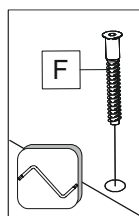
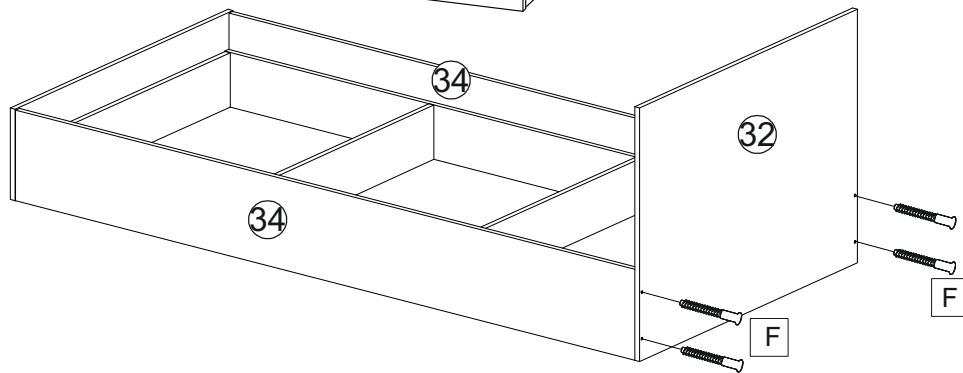
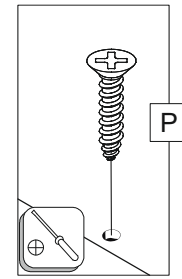
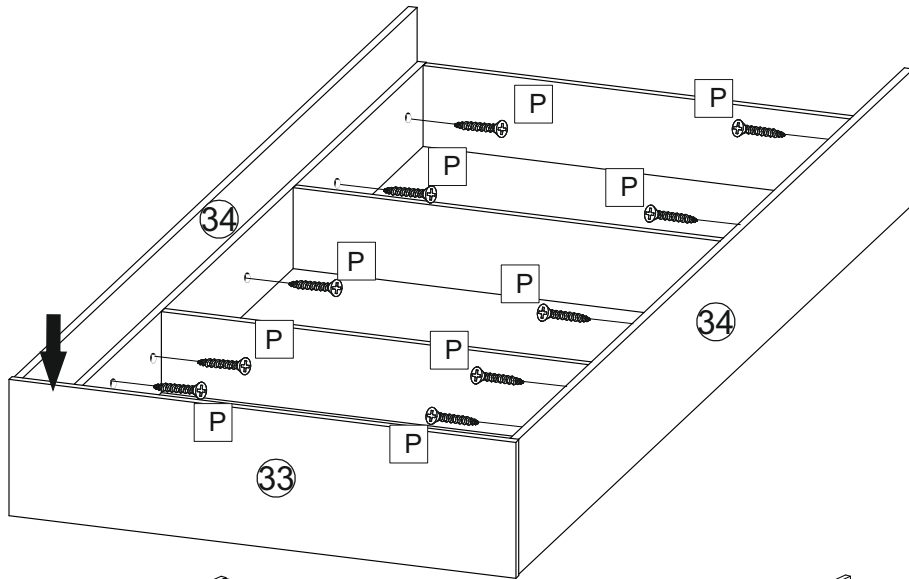
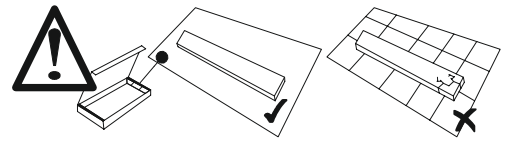

	
7x50	3,5x30
F x4	P x10



LD.520010.000-14/34

			
H	K	L	M
x4	x2	x28	x3

3,5x16

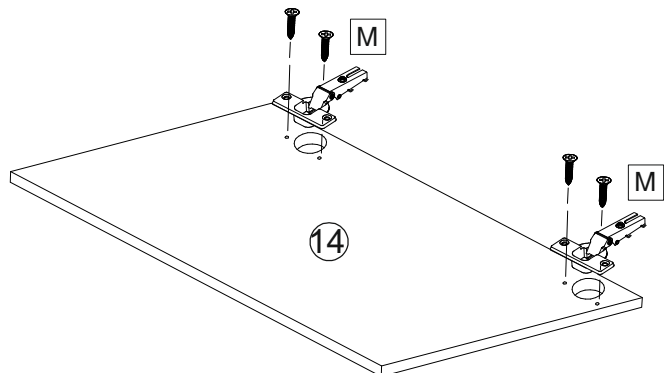
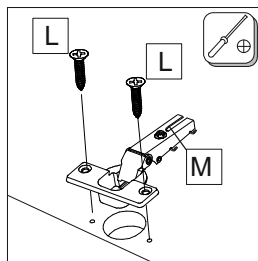
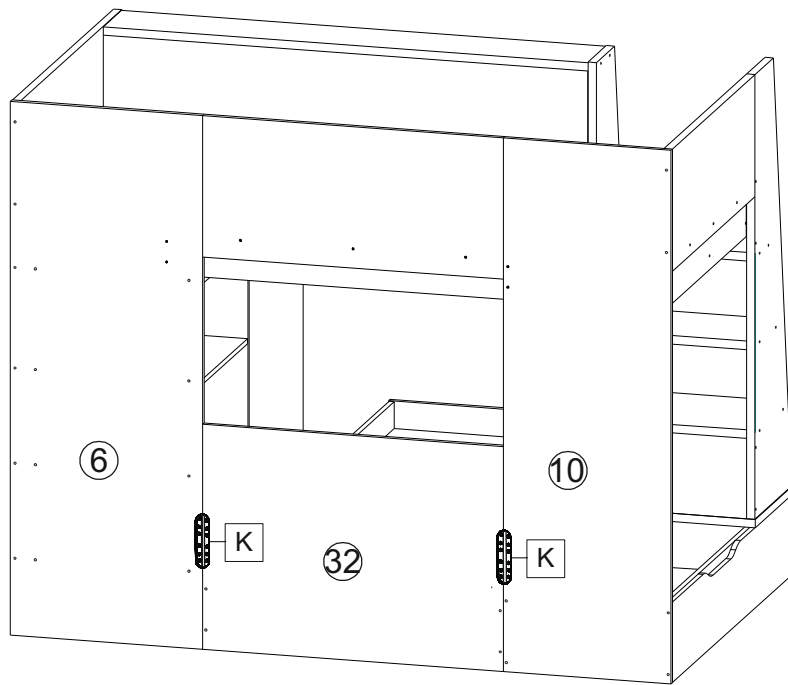
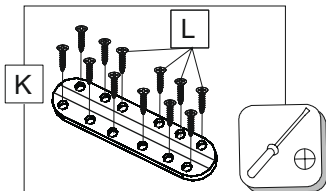
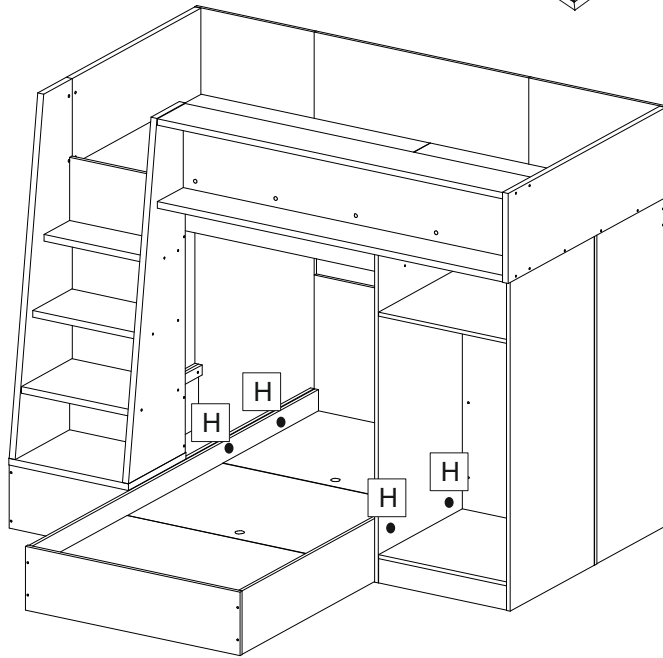
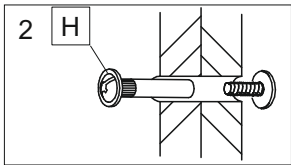
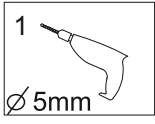
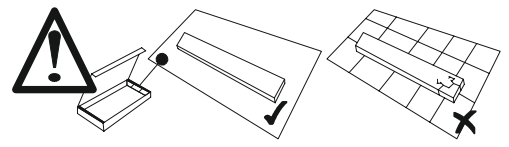

G	L	M	M	Q	Q	T	Y
x1	x11	x2	x2	x1	x1	x3	x1

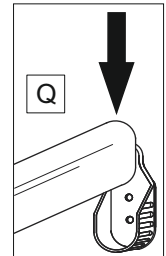
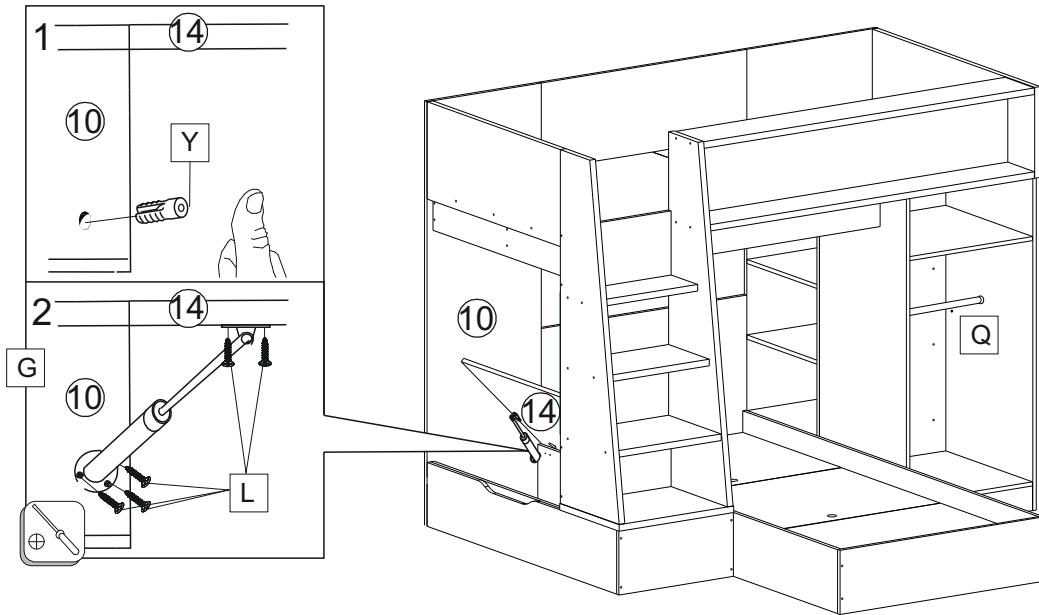
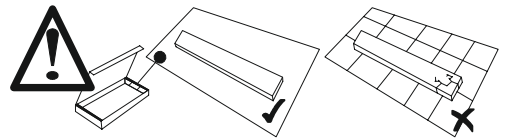

***Опция(Option)**



ЛД.519010.000/LD.519010.000

ДМ «Бэтмен» Фасад Кровати двухъярусной \
DM «Batman» Facade bunk bed

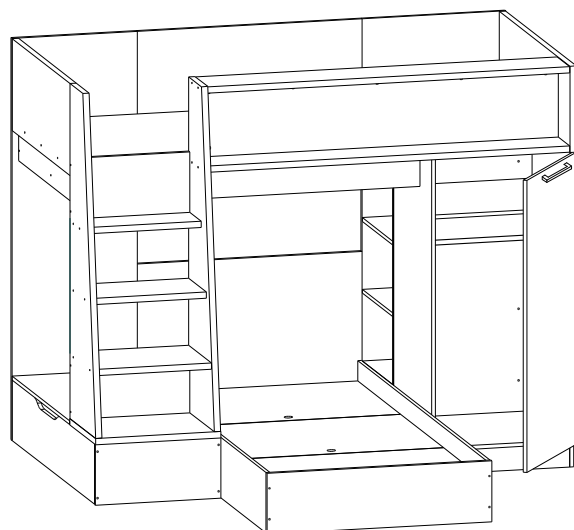
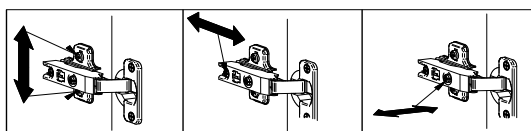
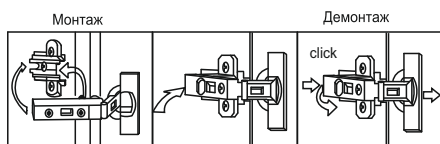
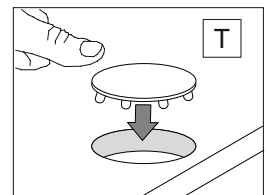
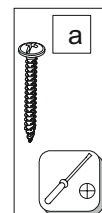
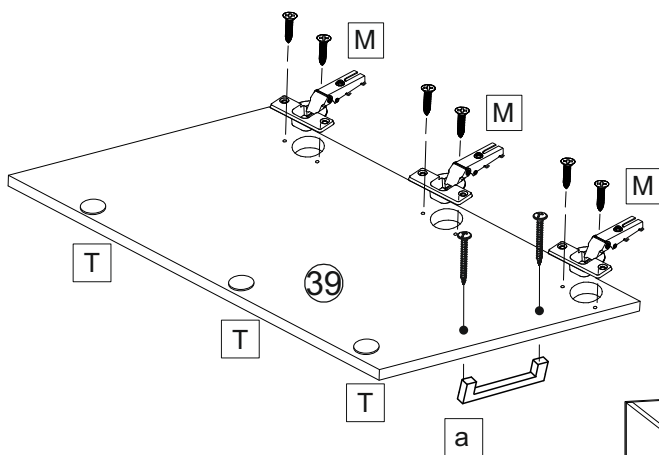
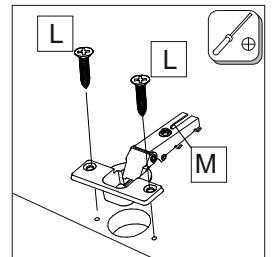
		39	519010.001	1
	a	x1		



LD.520010.000-16/34

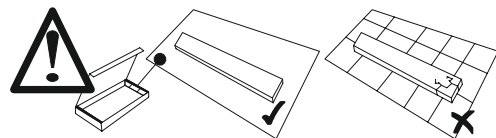

		
3,5x16		∅ 35mm
L x6	M x3	T x3



*Опция(Option)

ЛД.518010.000/LD.518010.000

ДМ «Футбол» Фасад Кровати двухъярусной \
DM «Football» Fasade Double-bunk bed

	④1 518010.001 1 1	
	 M4x22	
	a x1	b x1

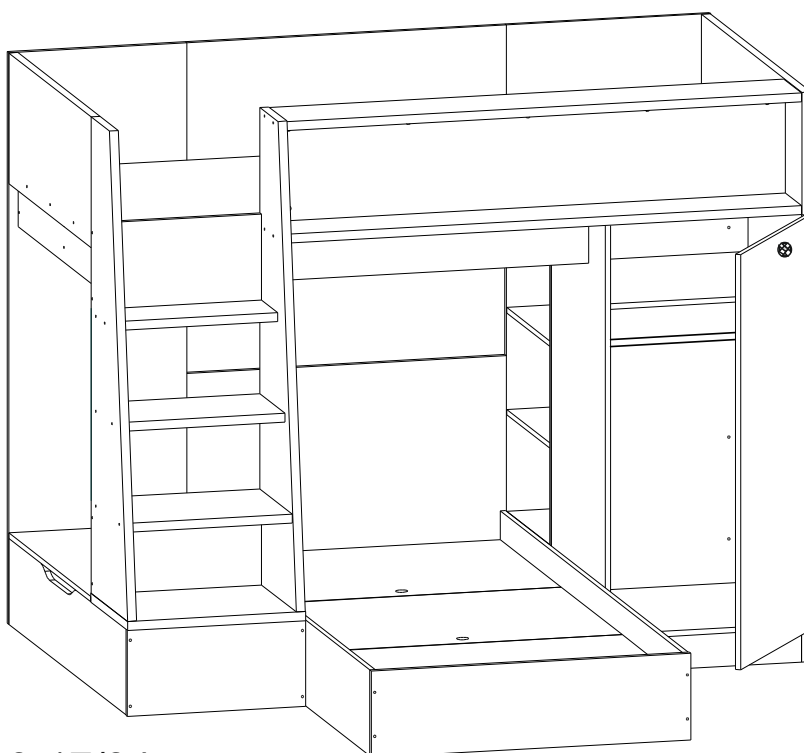
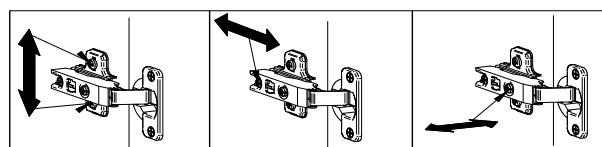
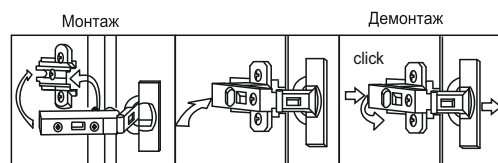
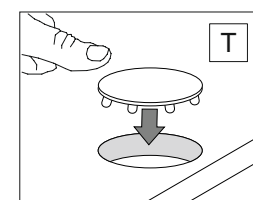
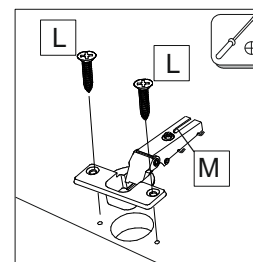
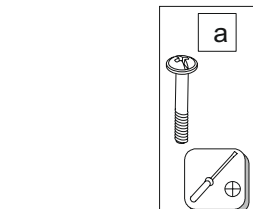
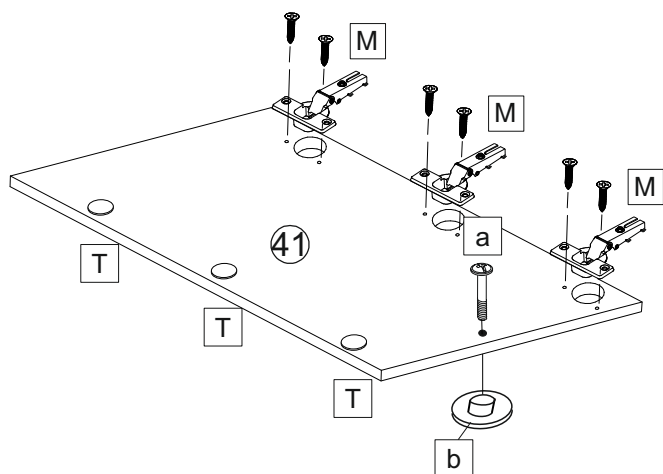



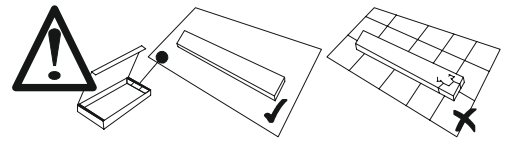

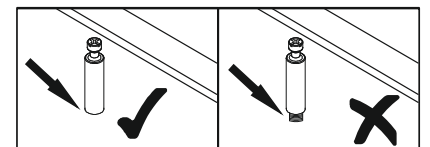
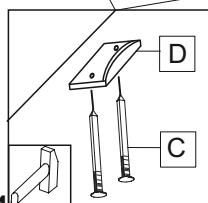
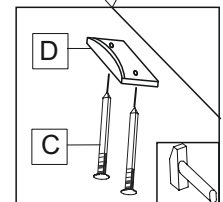
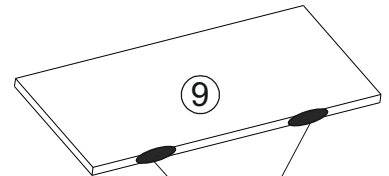
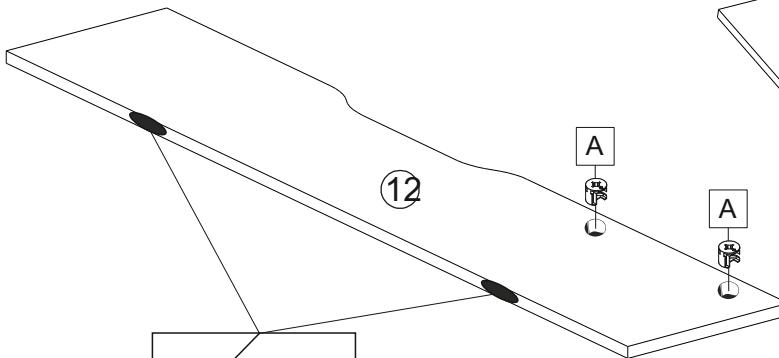
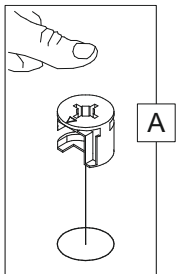
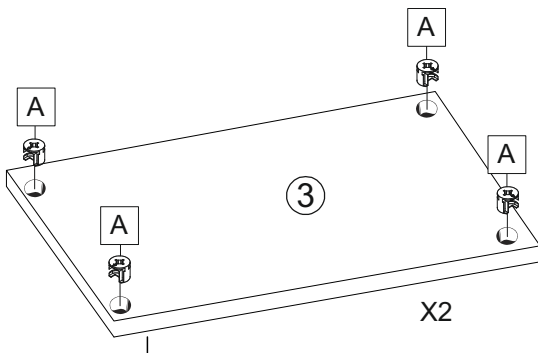
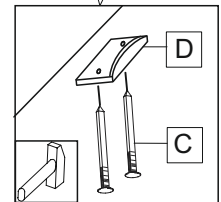
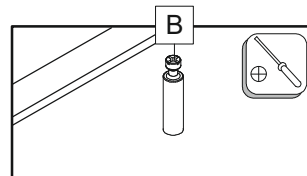
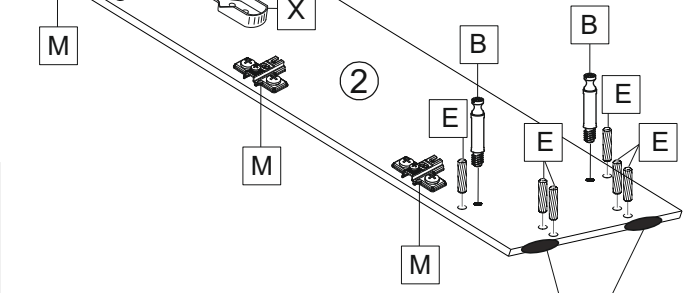
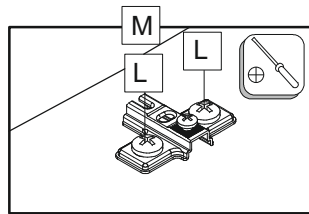
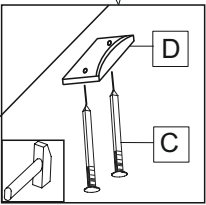
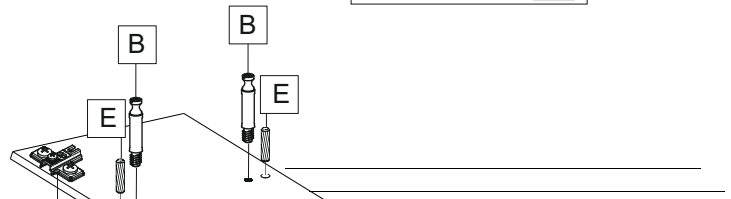
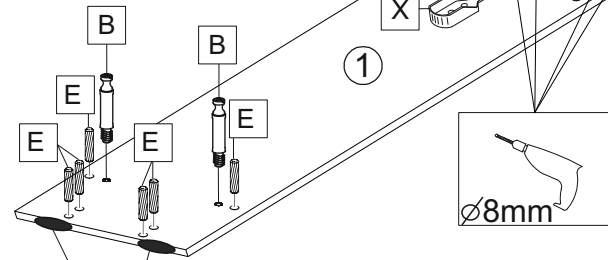
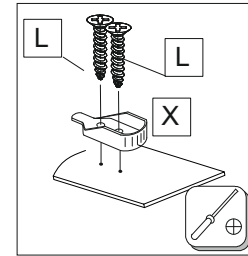
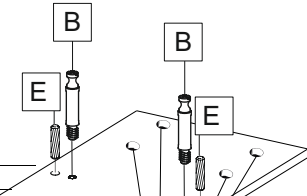
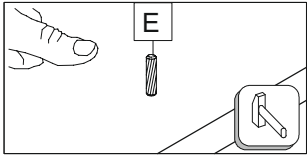

A x10	B x8	C x16	D x8	E x16	L x10
M x3	X x2				

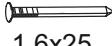

L

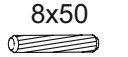

					
A	x2	B	x14	C	x20
		1,6x25			
M	x2	8x50			
	O	x3			

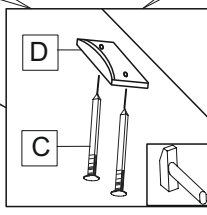
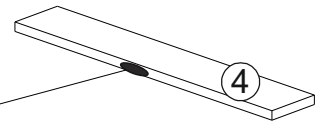
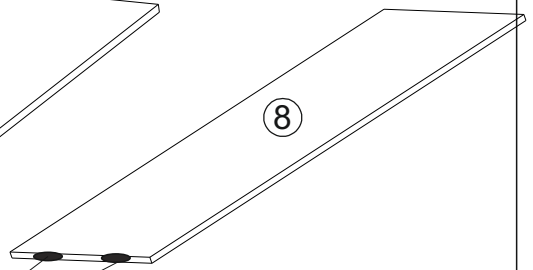
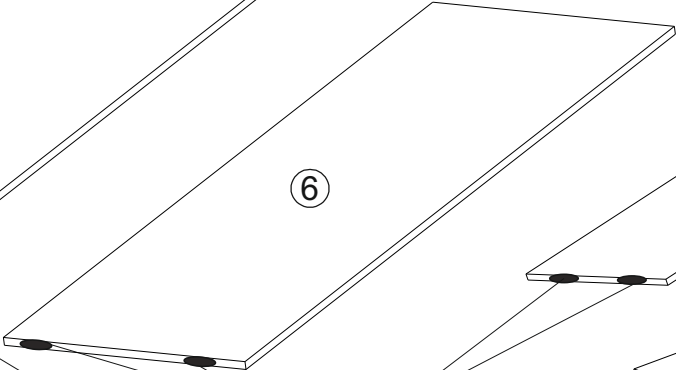
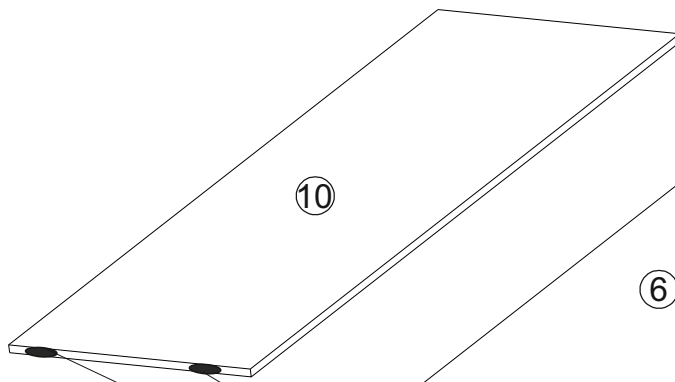
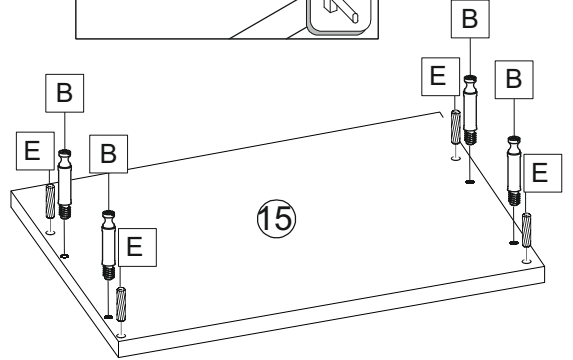
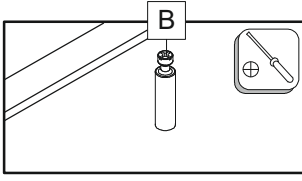
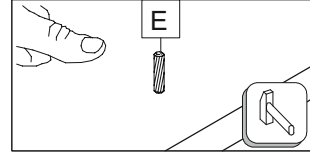
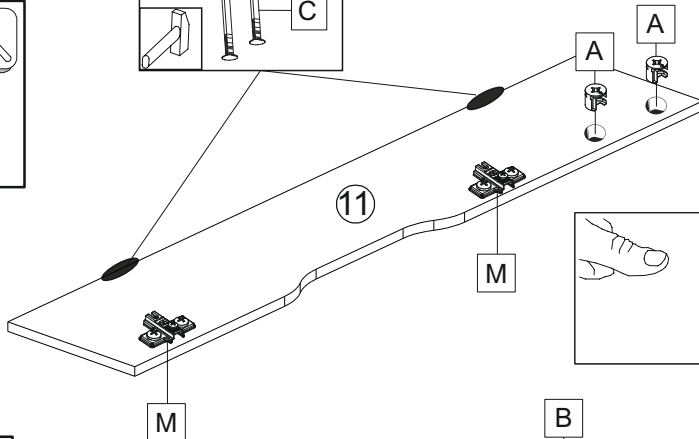
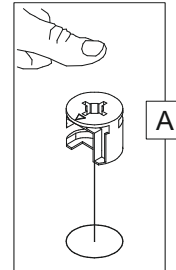
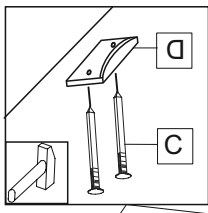
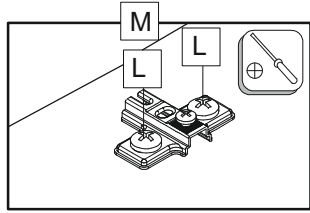
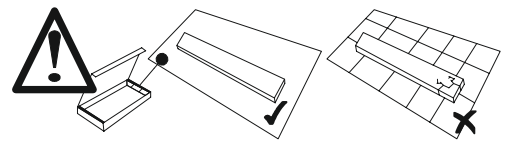

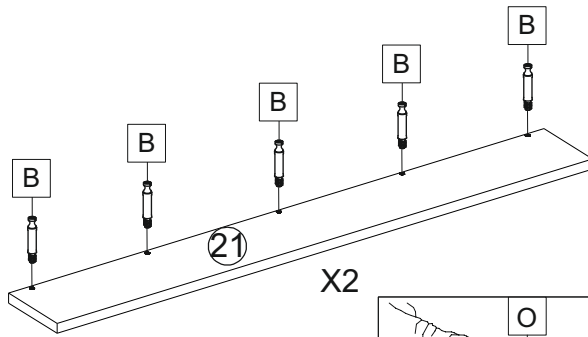

X2

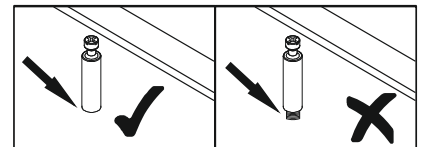
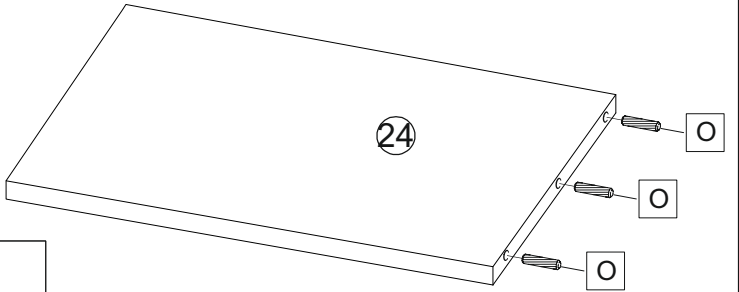
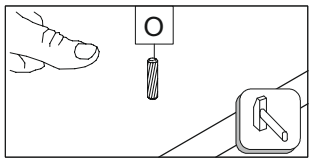

X2



8x50			
		7x50	
O	x4	F	x16

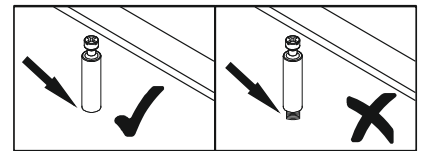
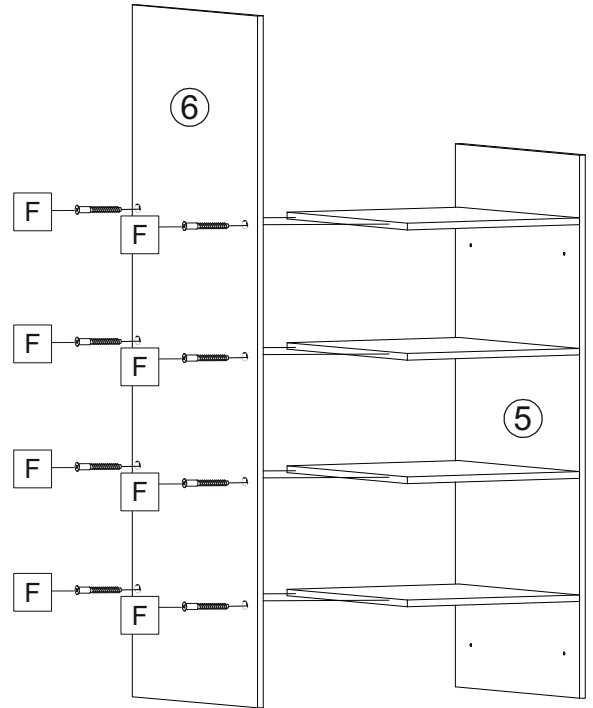
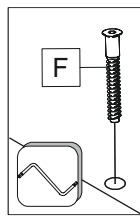
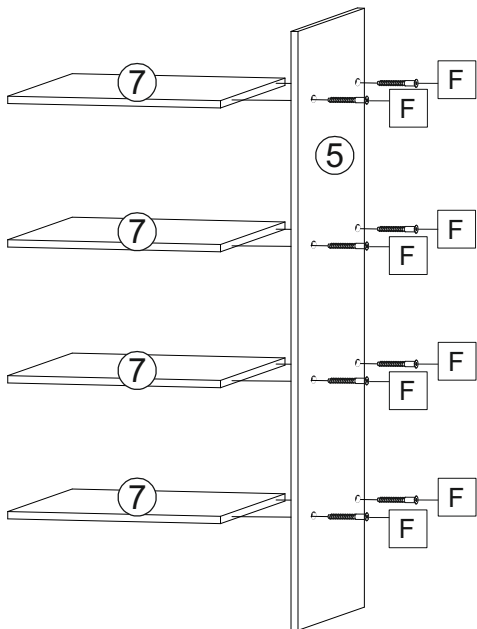
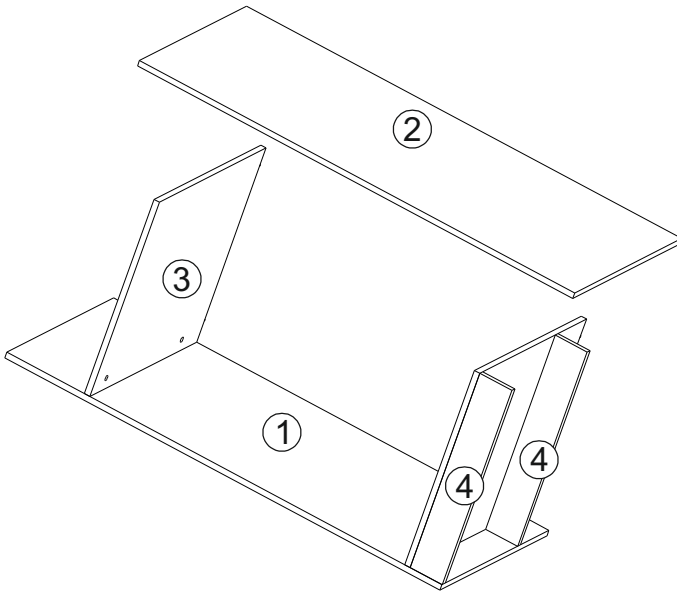
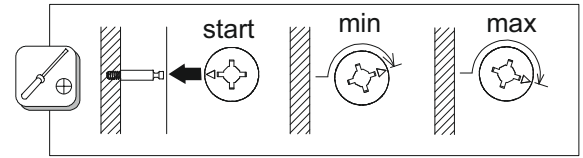
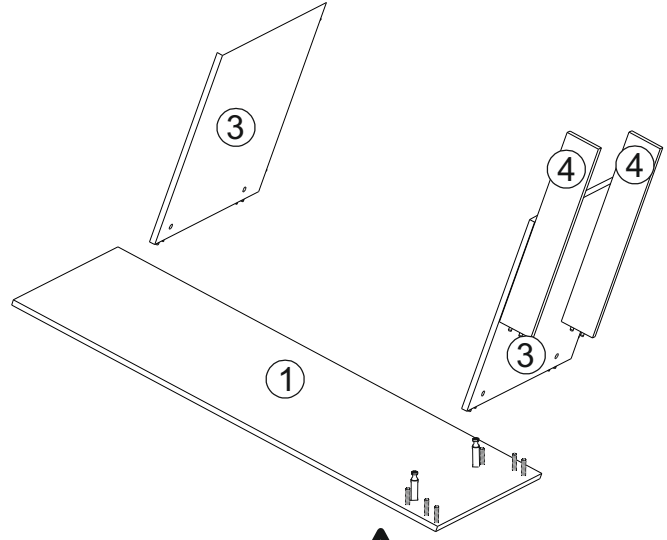
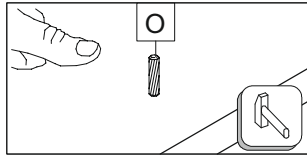
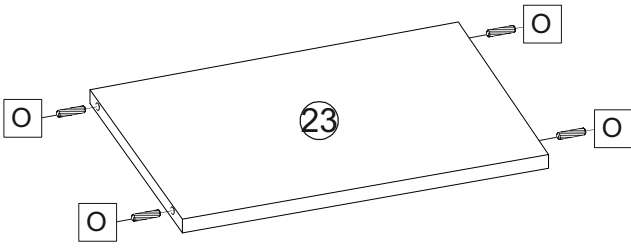
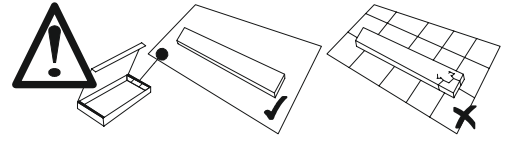



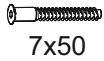
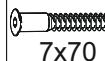

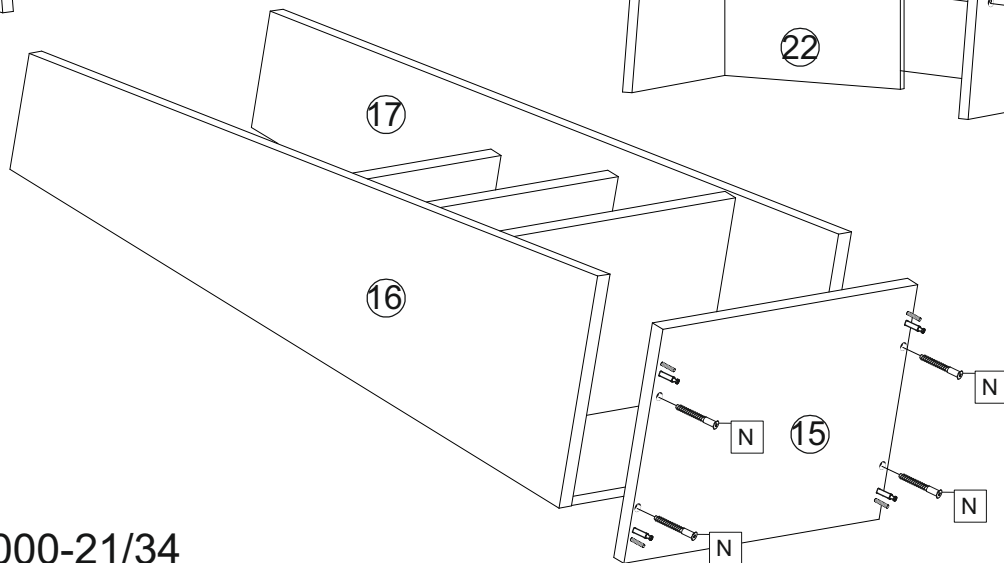
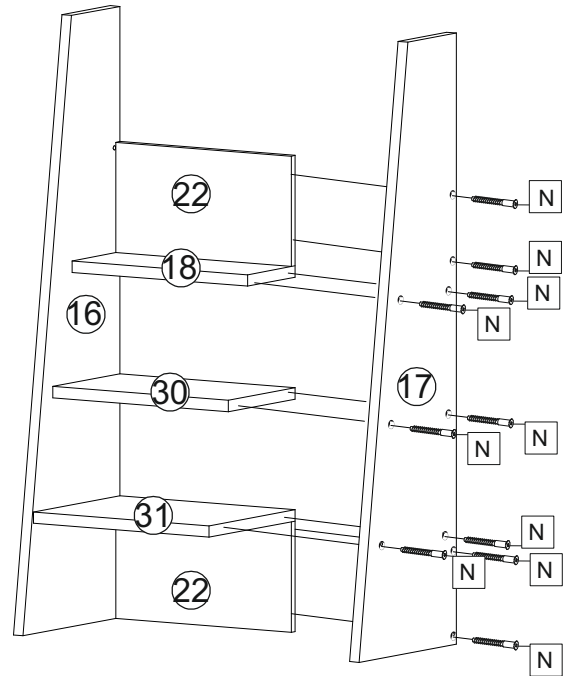
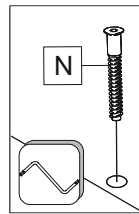
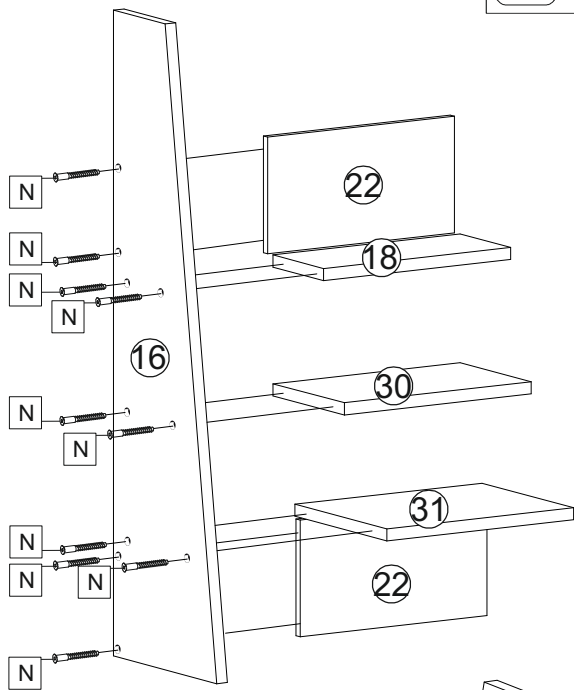
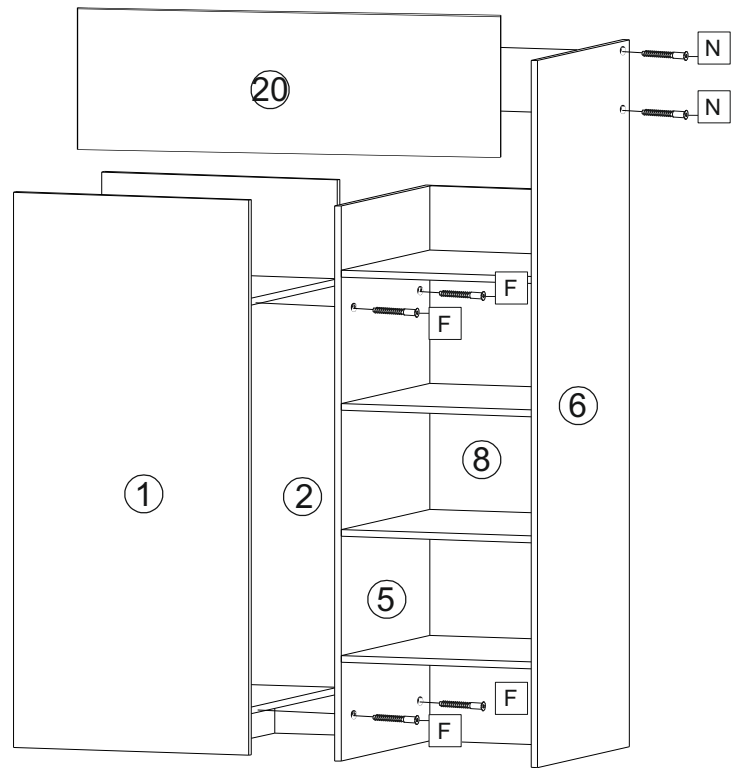
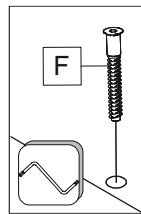
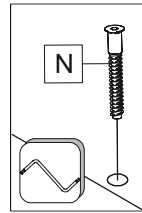
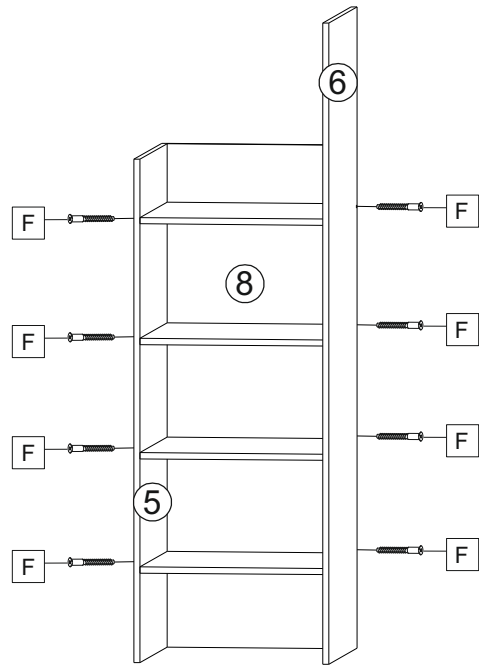
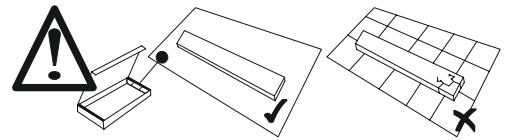
LD.520010.000-20/34

	
7x50	7x70
F x12	N x24

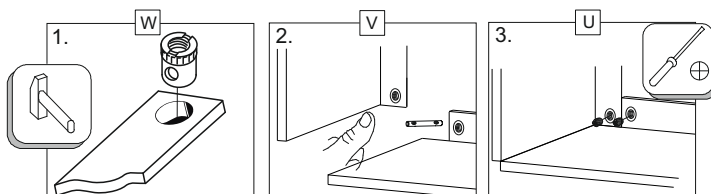
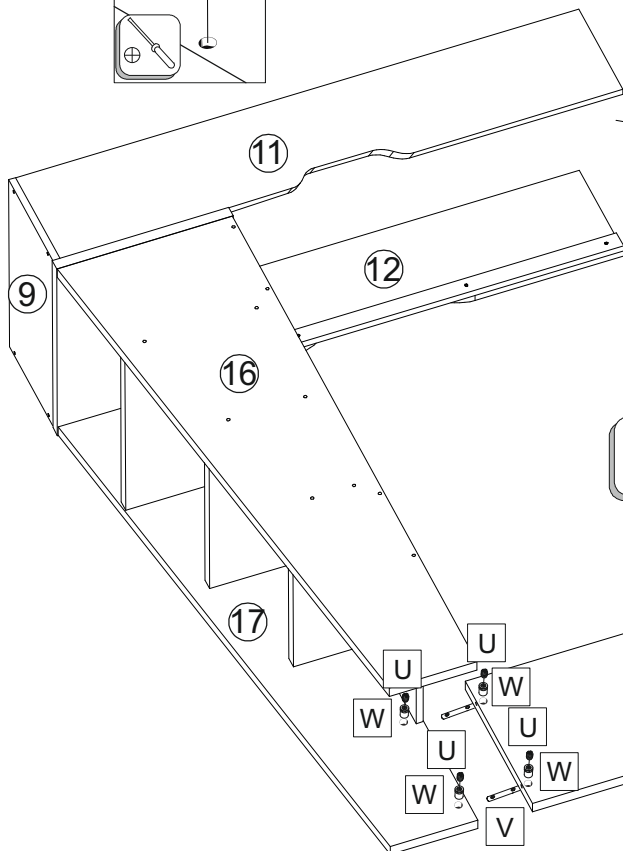
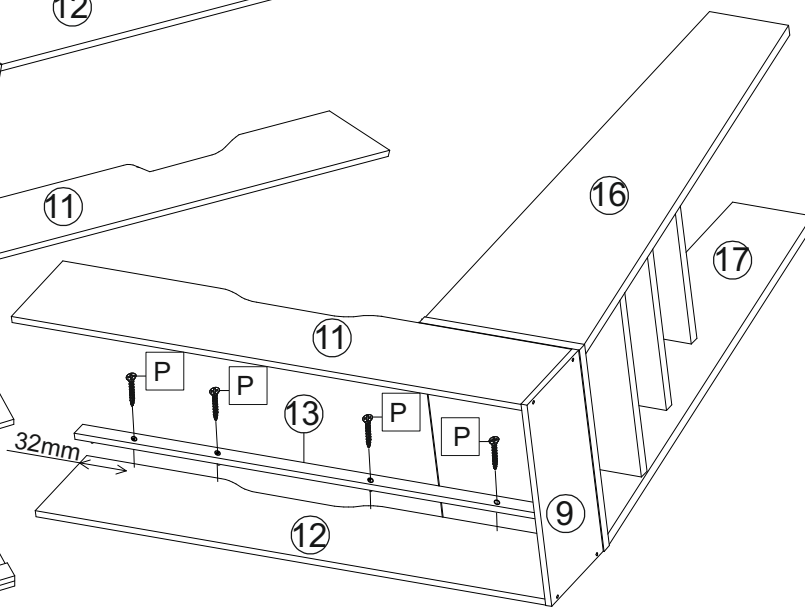
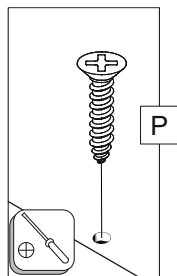
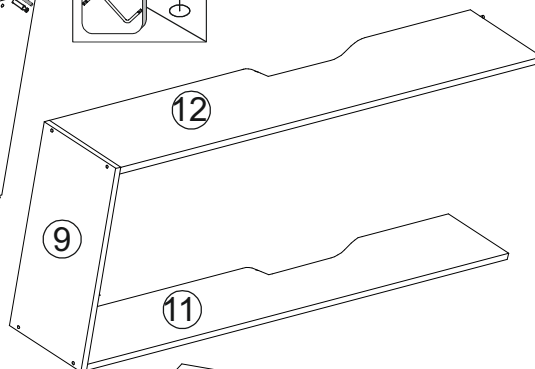
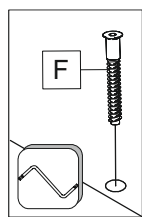
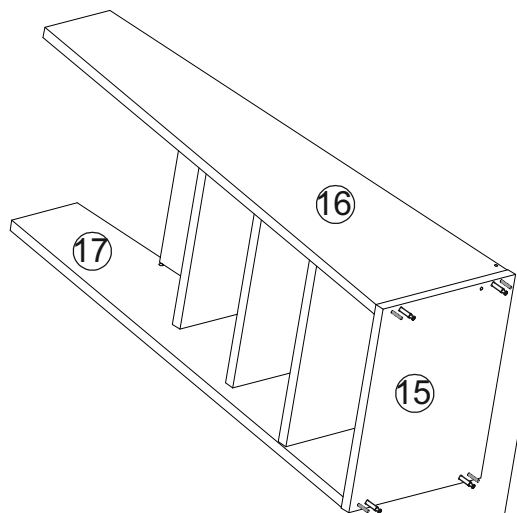
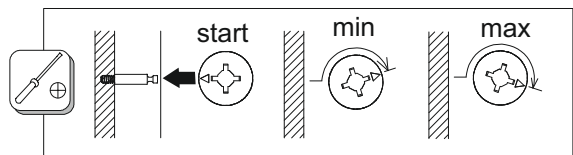
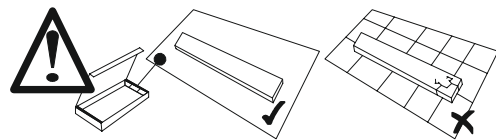

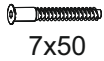

7x50	3,5x30			
F x4	P x4	U x4	V x2	W x4



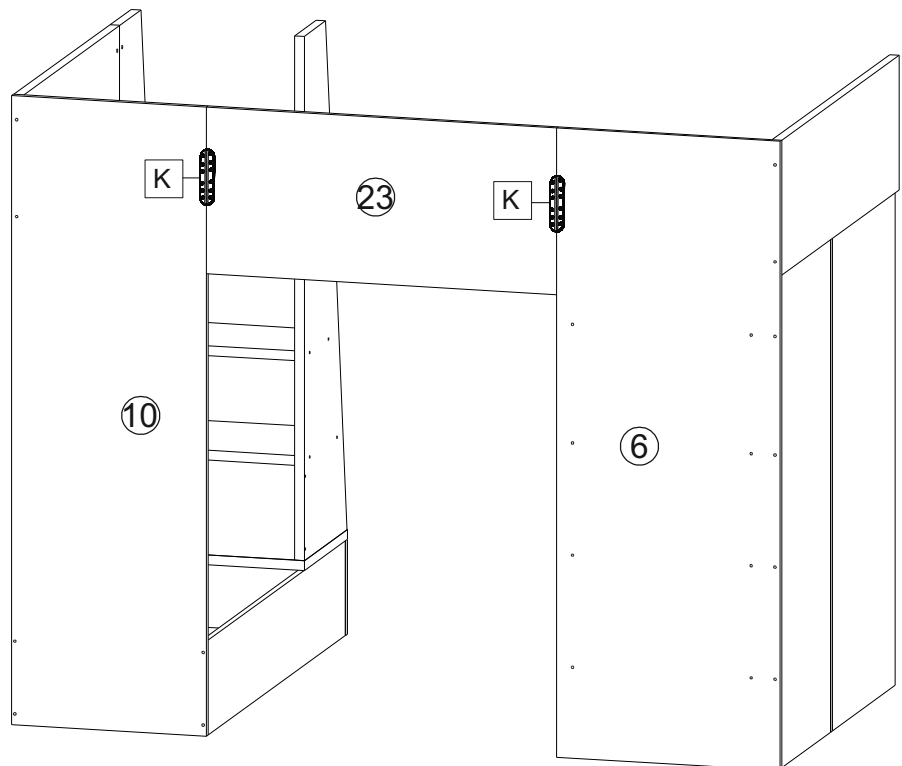
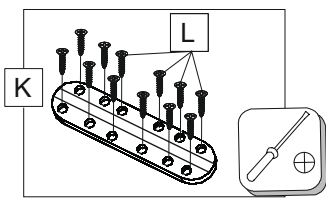
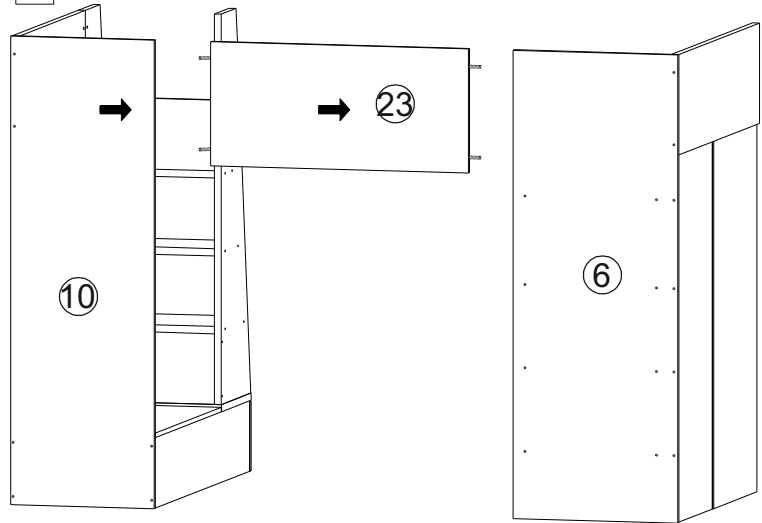
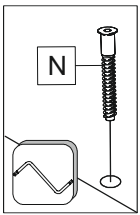
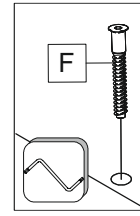
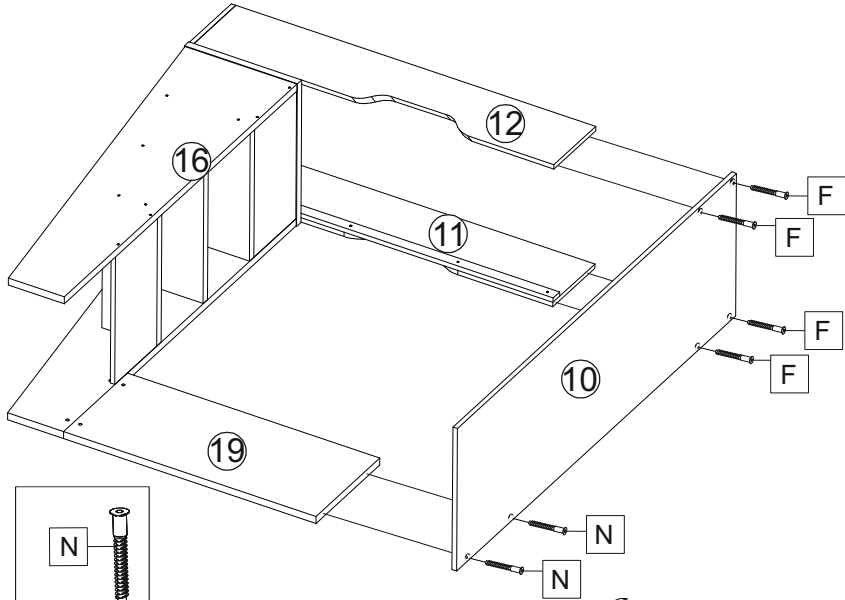
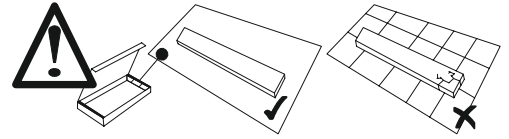

			
F x4	K x2	L x24	N x2



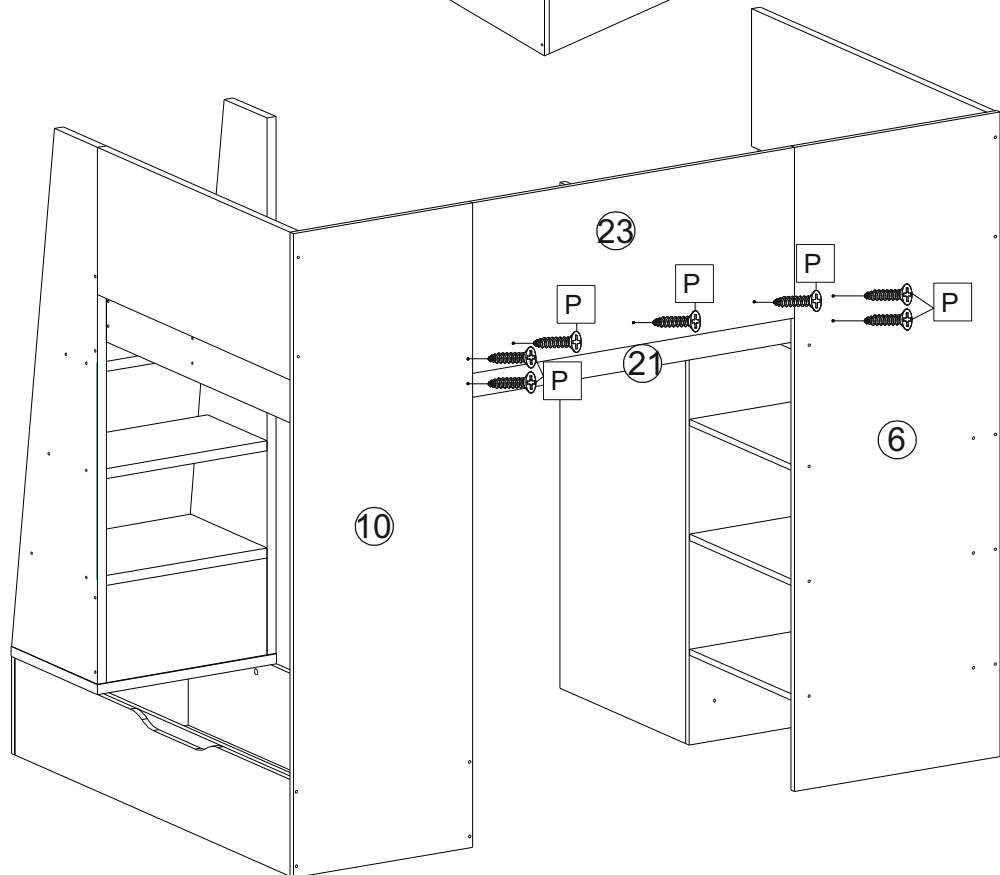
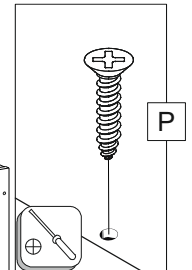
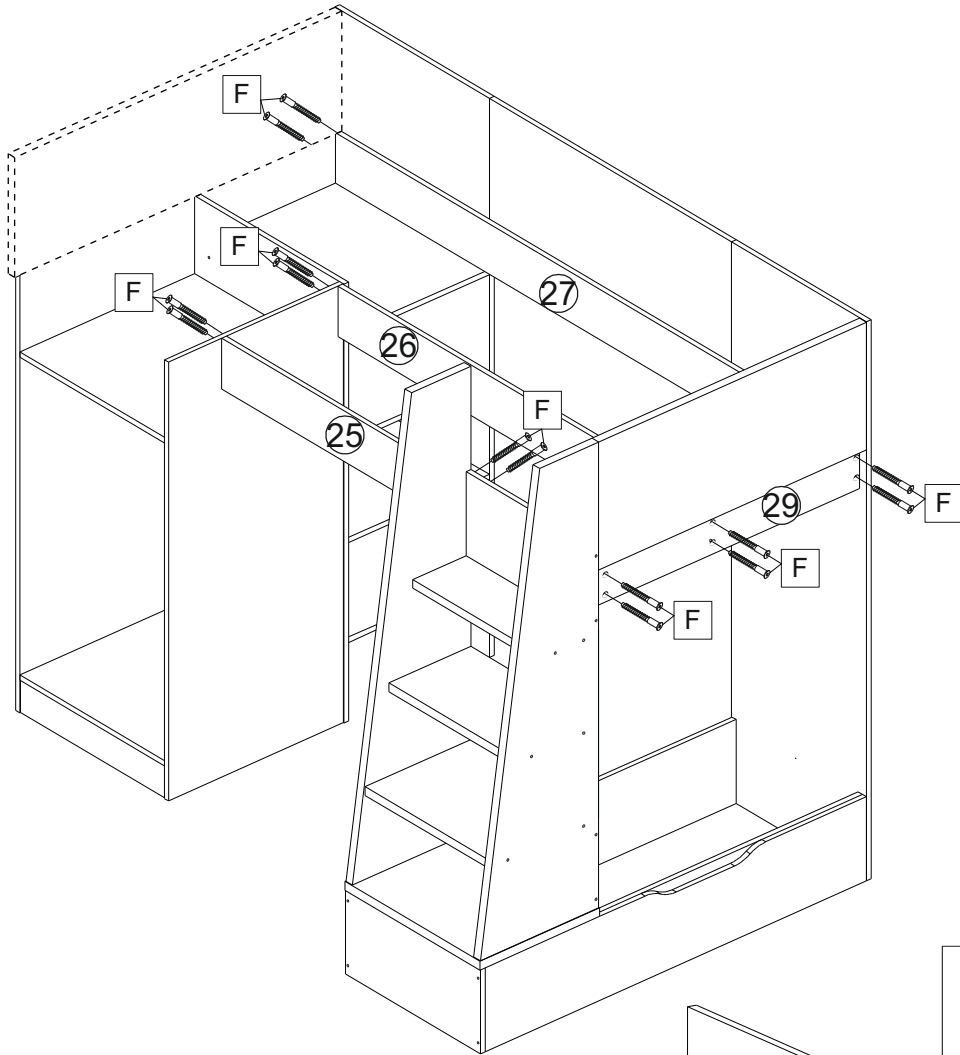
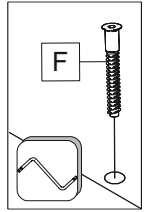
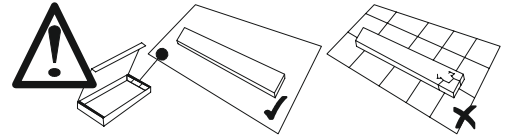

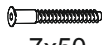

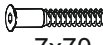
	
7x50	3,5x30
F x14	P x7

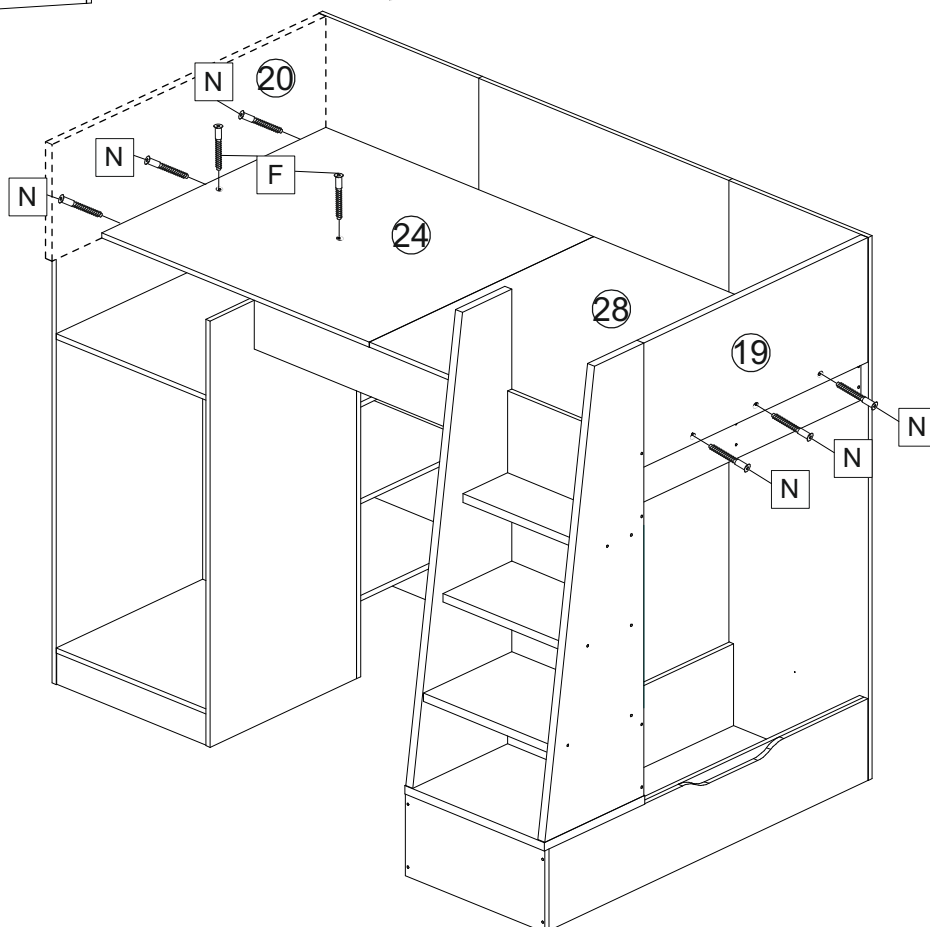
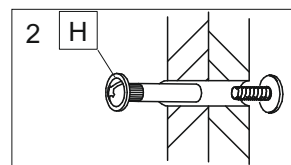
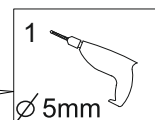
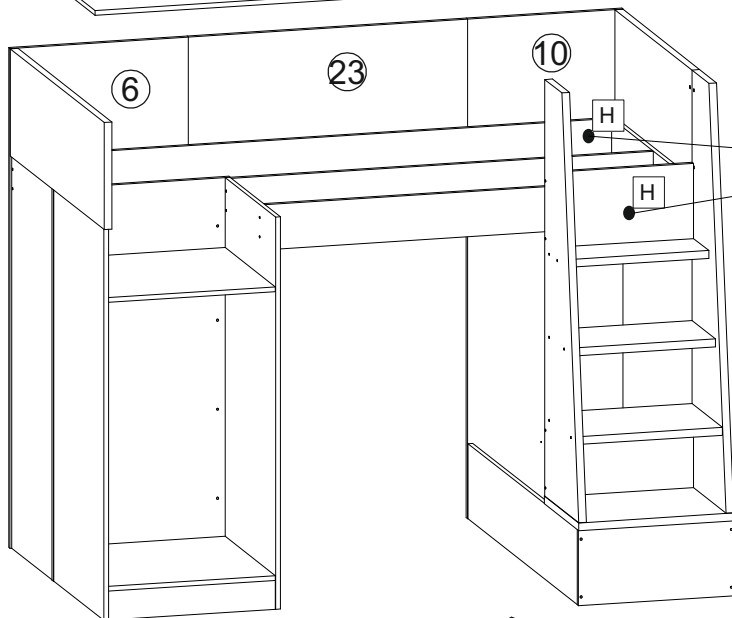
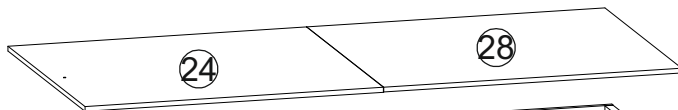
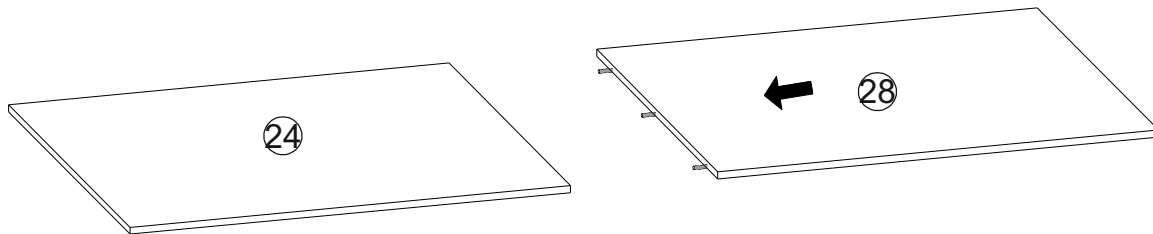
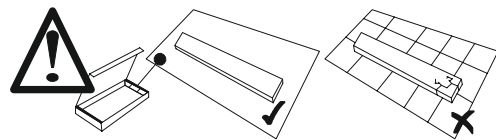

		
7x50	7x70	7x70
F x2	H x2	N x6



			
A	3,5x16	L	R
x10	x60	x15	

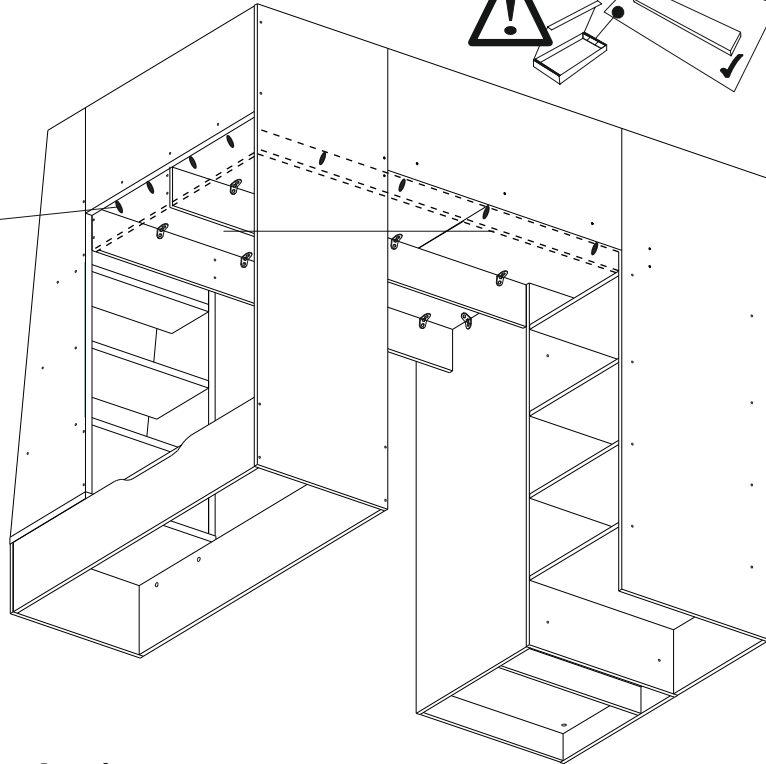
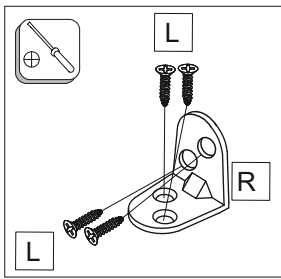
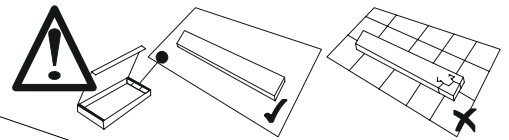



***Опция(Option)**

ЛД.519010.000/LD.519010.000

ДМ «Бэтмен» Фасад Кровати двухъярусной \
DM «Batman» Facade bunk bed

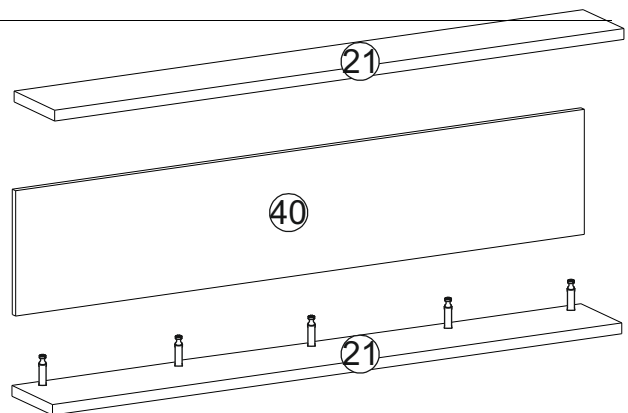
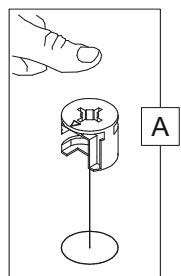
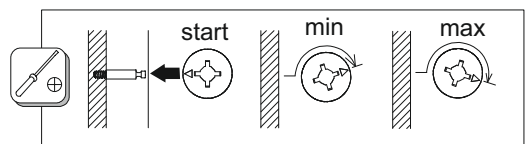
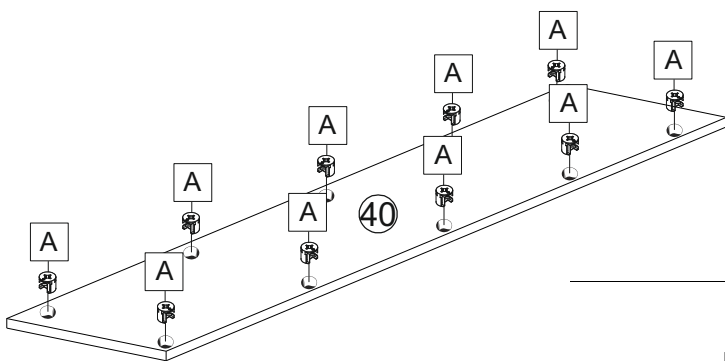
	Ⓞ 519010.002	1
--	--------------	---

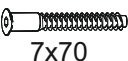

	
A x10	N 7x70
N x8	

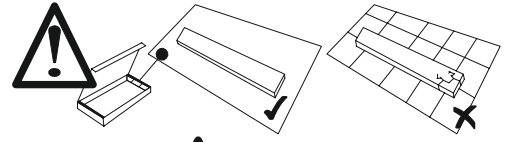



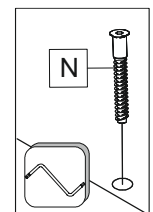
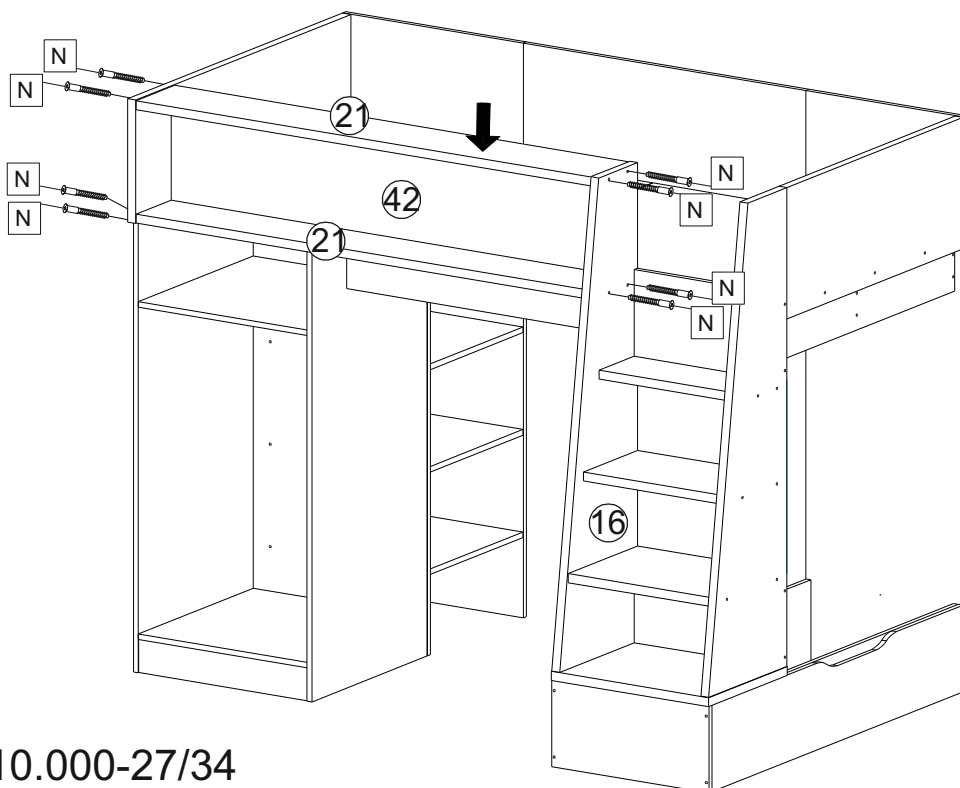
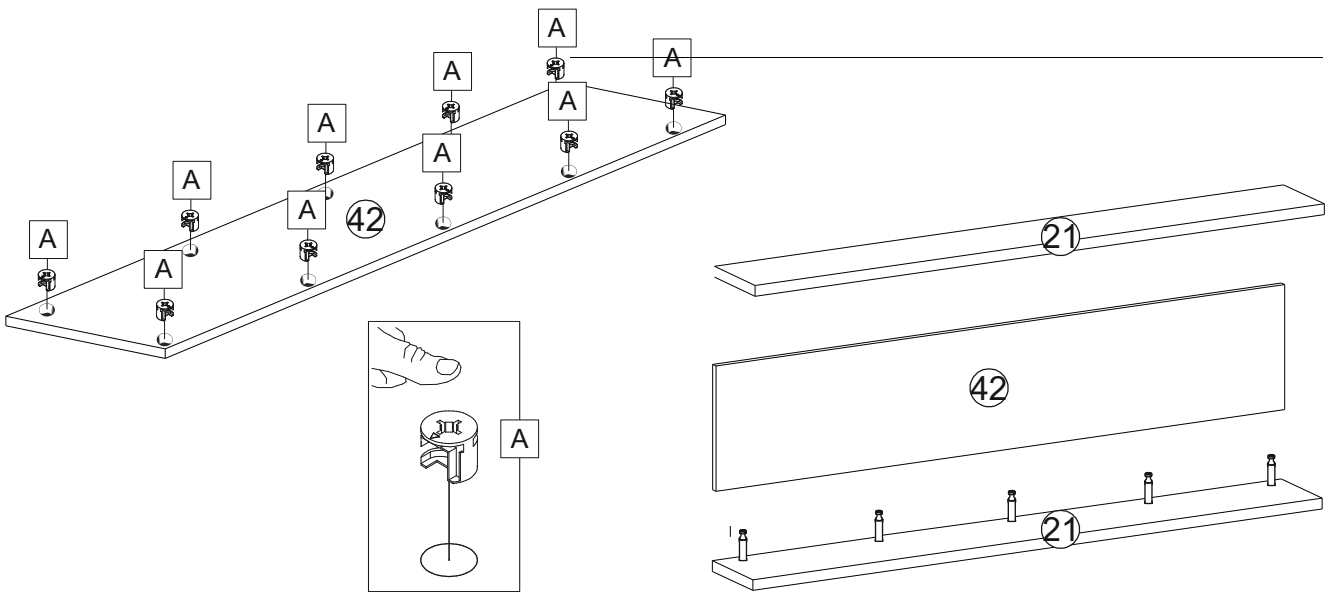
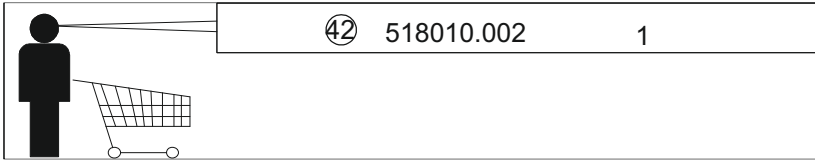
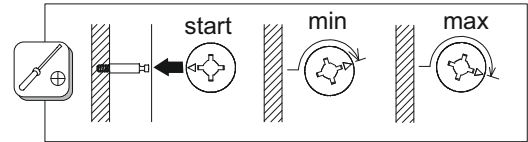

***Опция(Option)**

ЛД.518010.000/LD.518010.000

ДМ «Футбол» Фасад Кровати двухъярусной \
DM «Football» Fasade Double-bunk bed



			
H	K	L	M
x4	x2	x28	x3

3,5x16

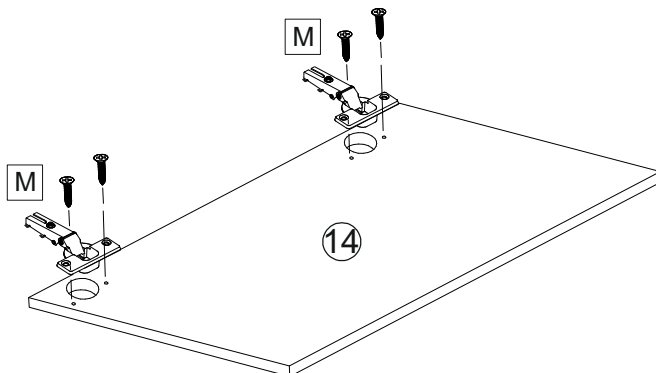
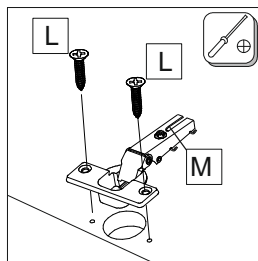
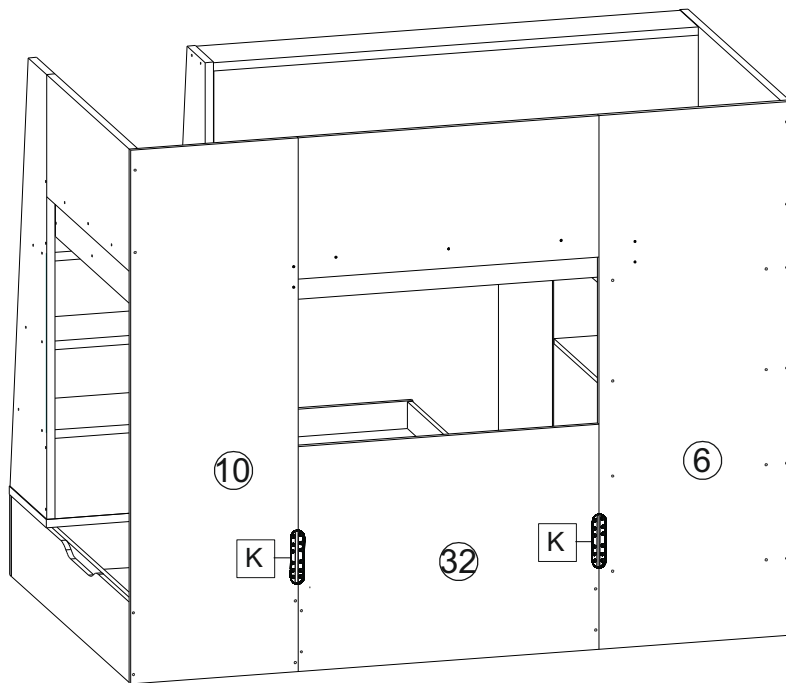
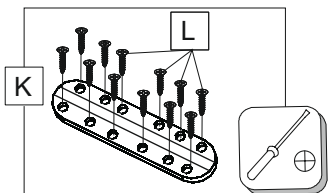
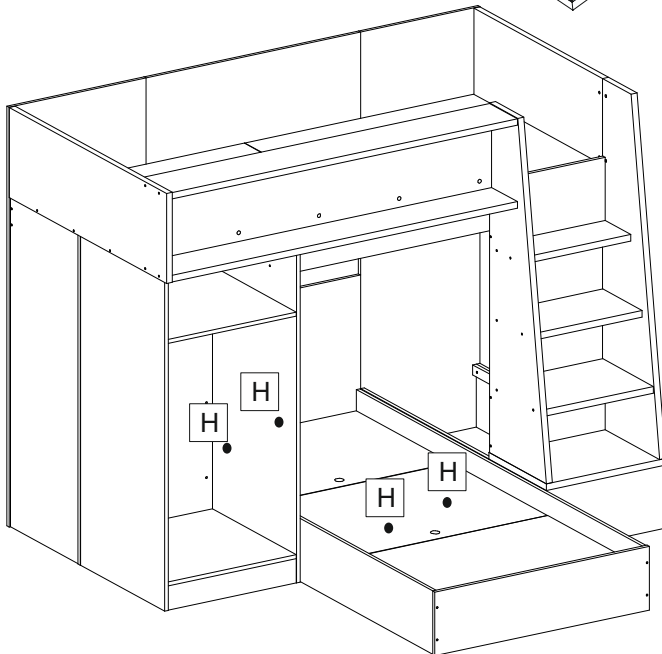
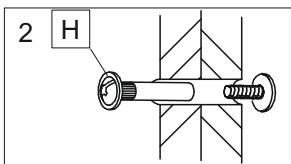
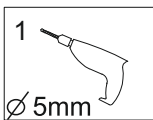
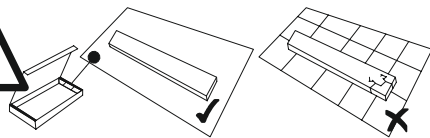

G	x1	L	x11	M	x2	Q	x1	T	x3	Y	x1

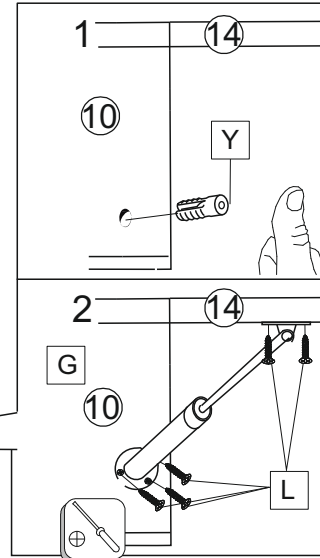
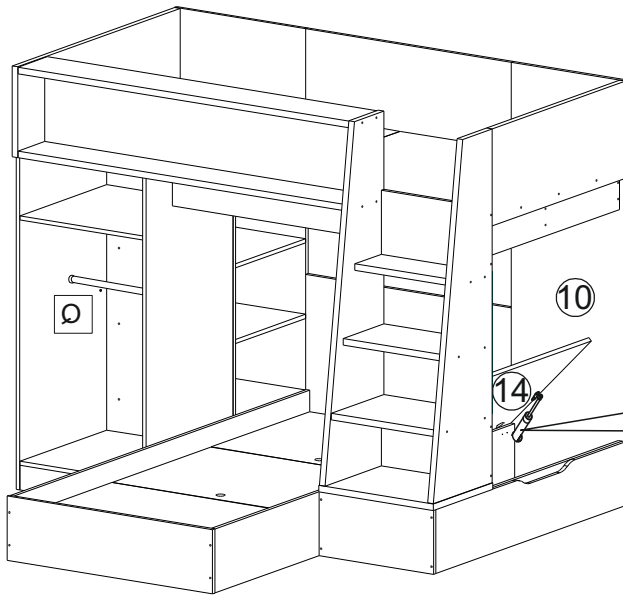
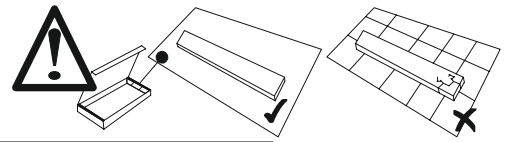

***Опция(Option)**

ЛД.519010.000/LD.519010.000

ДМ «Бэтмен» Фасад Кровати двухъярусной \
DM «Batman» Facade bunk bed

		39	519010.001	1
	a	x1		

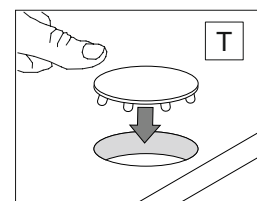
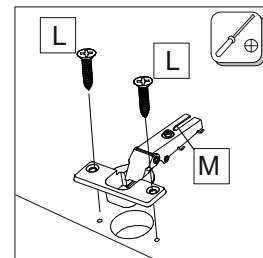
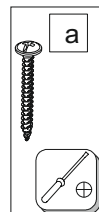
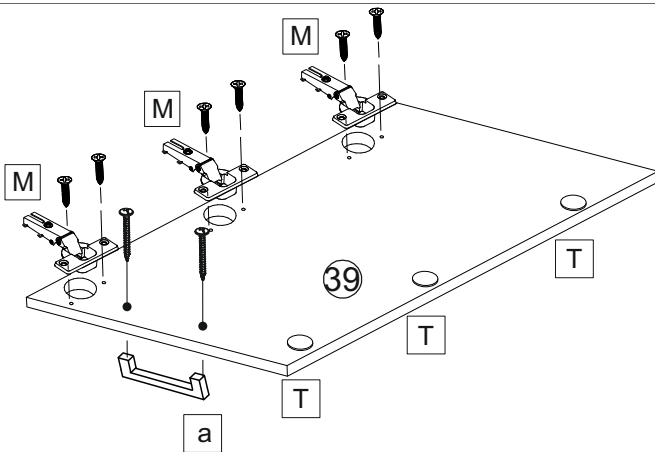



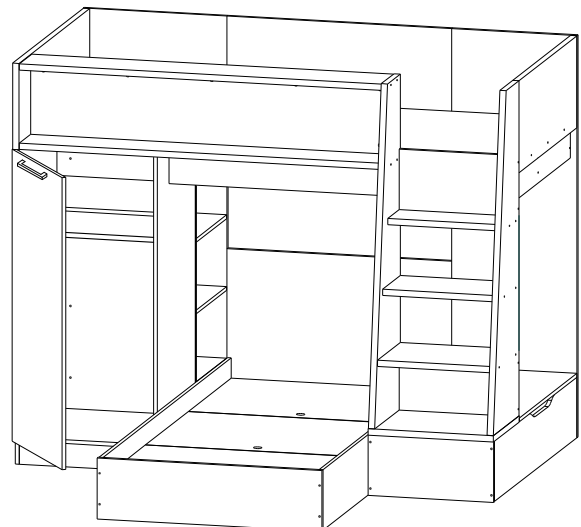
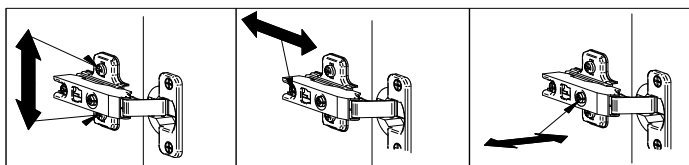
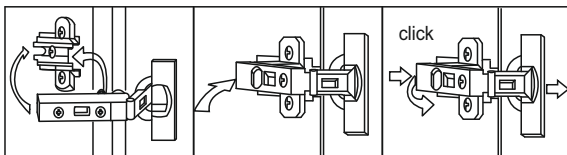

Монтаж

Демонтаж



LD.520010.000-29/34

			
3,5x16	L	M	T
x6	x3	x3	

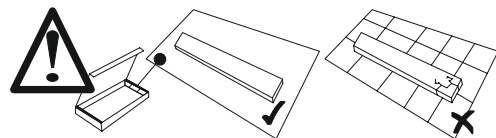



*Опция(Option)

ЛД.518010.000/LD.518010.000

ДМ «Футбол» Фасад Кровати двухъярусной \
DM «Football» Fasade Double-bunk bed

④1	518010.001	1
----	------------	---

	
M4x22	a
x1	x1

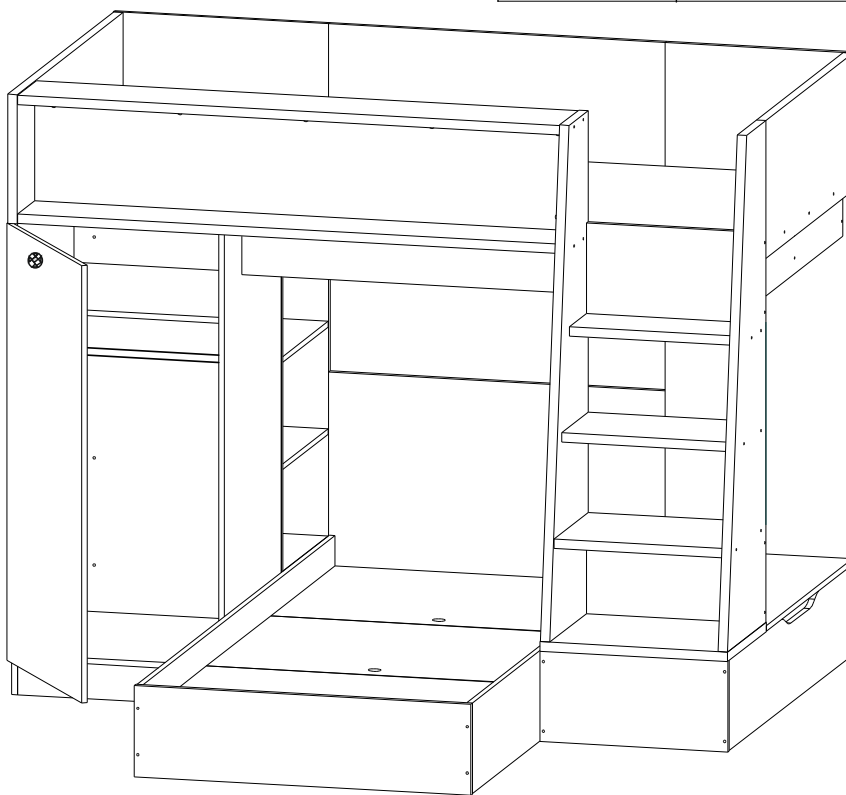
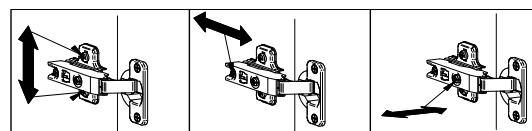
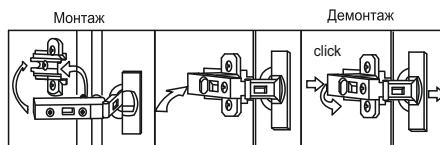
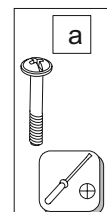
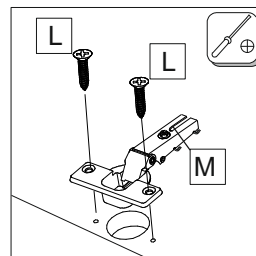
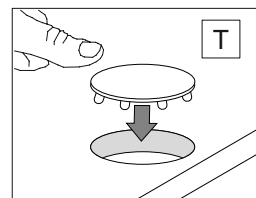
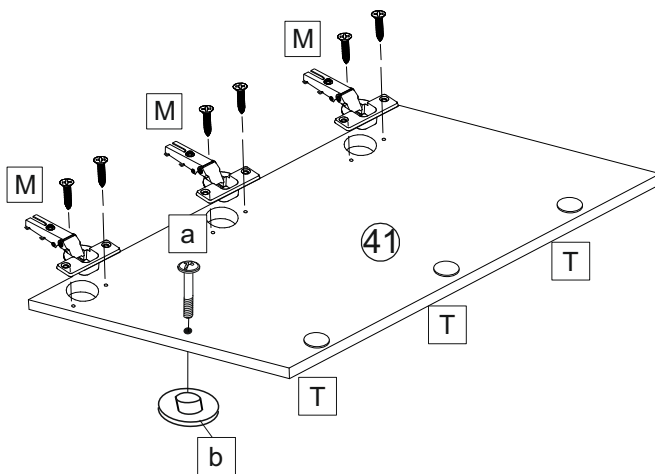

LD.520010.000-30/34

*Опция(Option)

ЛД.520140.000/LD.520140.000

DM «Модерн»Комплект накладок для ступеней \
DM «Modern»Cover set for steps

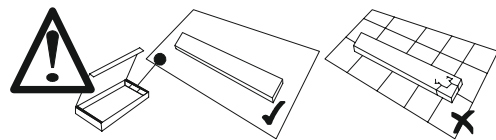

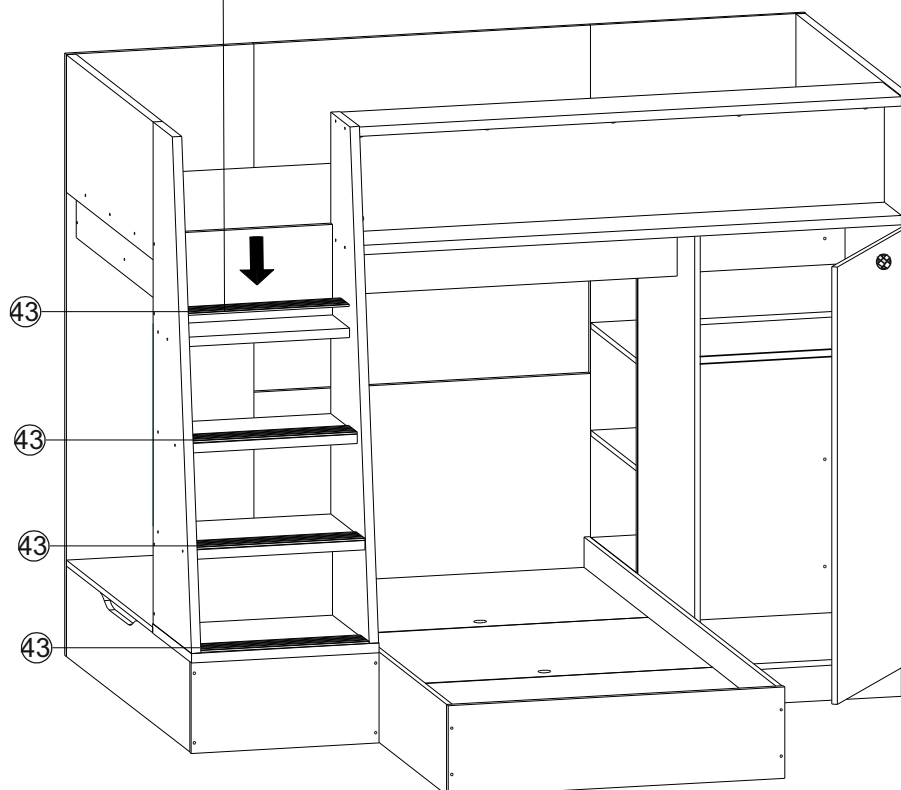
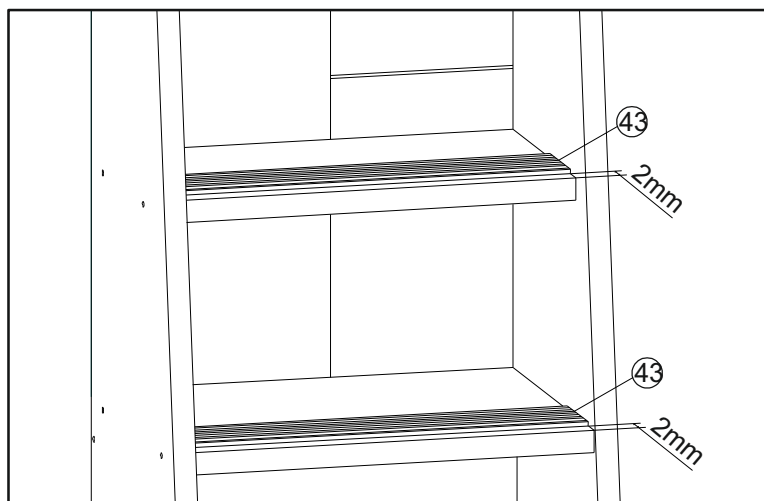
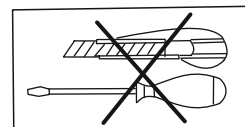
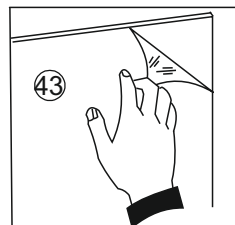
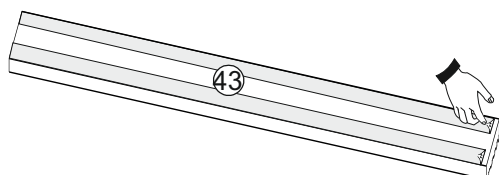

43	520140.001	4
----	------------	---



*Опция(Option)

ЛД.518010.000/LD.518010.000

ДМ «Футбол» Фасад Кровати двухъярусной \
DM «Football» Fasade Double-bunk bed

		
3,5x30		
с x4	d x4	e x1

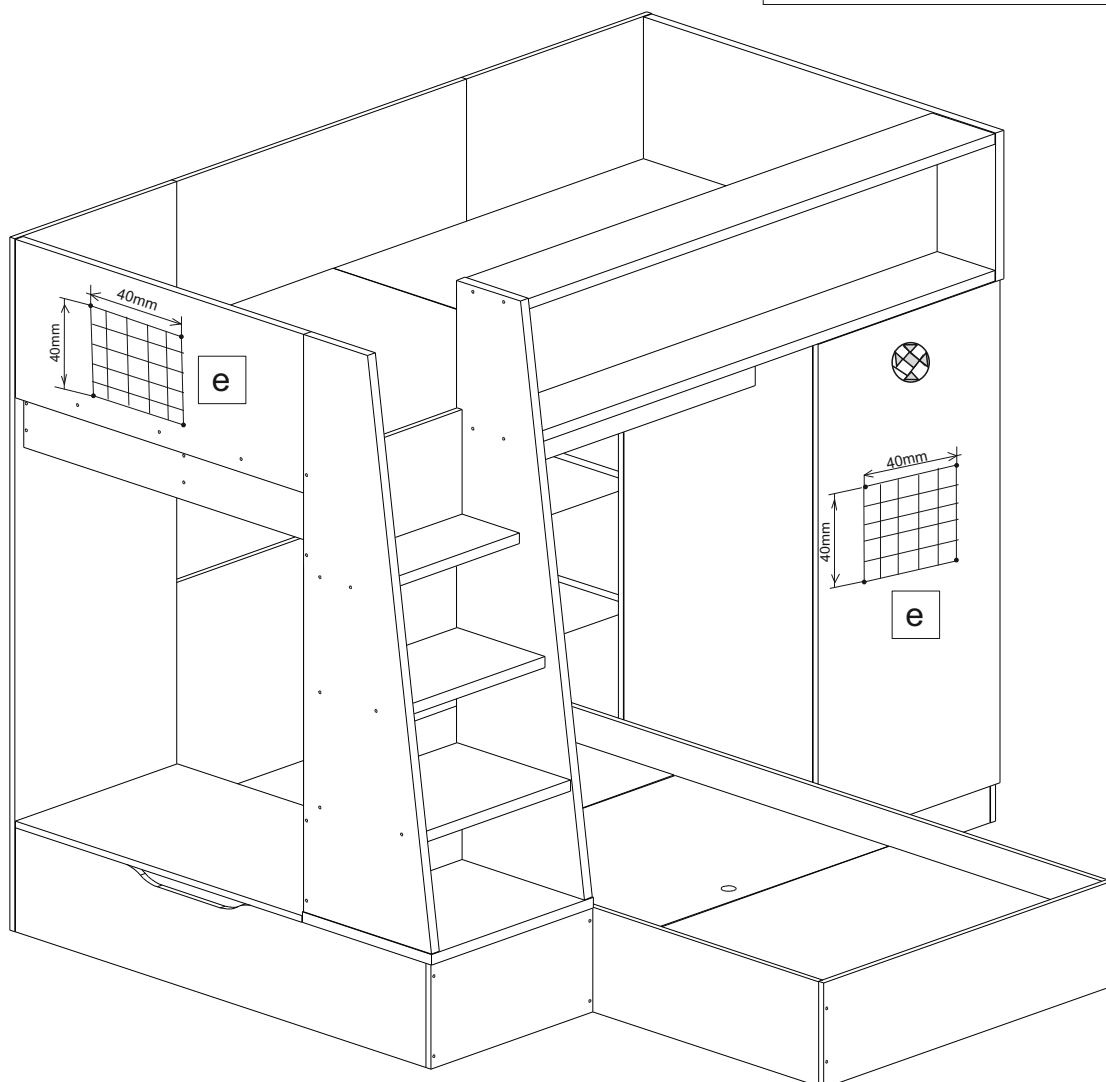
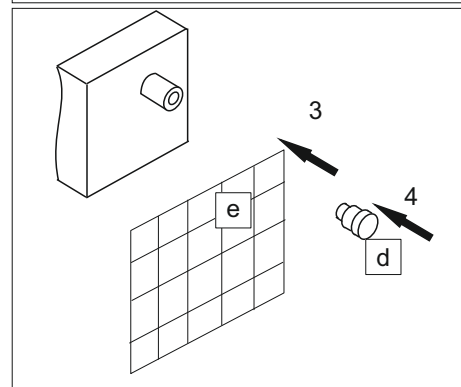
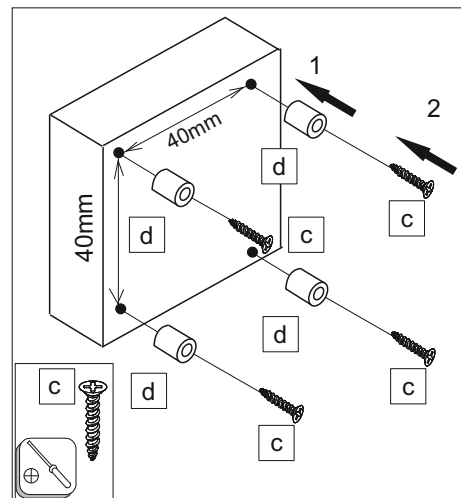



LD.520010.000-32/34

*Опция(Option)

ЛД.518150.000/LD.518150.000

ДМ «Футбол» спинка мягкая \

DM «Football» Headboard soft

44		518150.000		1	
	3,5x41		3,5x30		Ø14
a	x4	b	x4	c	x4

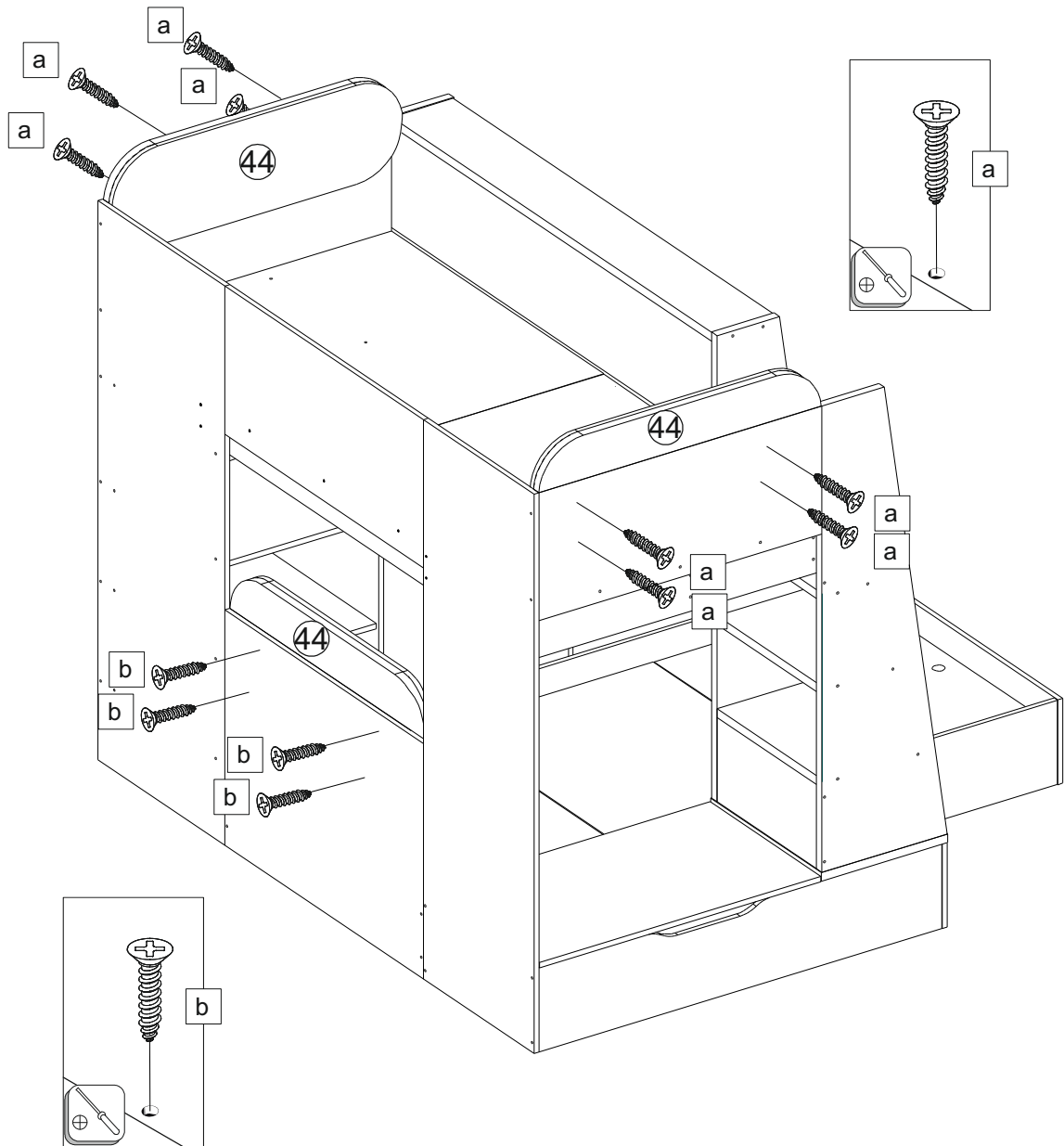

Уважаемый покупатель!

- Для удобства транспортирования и предотвращения повреждений, изделия поставляются в разобранном виде. Стоимость сборочных работ в стоимость изделия не включена.
- Сборку рекомендуется производить с помощью специалиста, так как неправильная сборка может привести к повреждениям мебели и(или) её опрокидыванию.
- Предприятие-изготовитель оставляет за собой право вносить незначительные конструктивные изменения, не ухудшающие внешний вид и не влияющие на функциональные свойства изделия.
- Для идентификации изделия рекомендуем сохранять упаковку с этикетками изделия до конца сборки.
- Все изделия мебели прошли процедуру обязательного подтверждения соответствия в форме сертификации или декларирования.

Гарантийный срок эксплуатации мебели:

НТД	Детской и для общественных помещений	бытовой
ГОСТ 16371-2014	18 мес	24 мес
ГОСТ 19917-2014	12 мес	18 мес

Установленный срок службы изделий мебели- 5 лет.

!!! Срок службы можно значительно продлить при бережном уходе и выполнении правил эксплуатации

ПРАВИЛА ЭКСПЛУАТАЦИИ И УХОДА ЗА МЕБЕЛЬЮ

1. Расстояние от источника тепла должно быть не менее 1 метра. Не допускайте соприкосновения горячих предметов с мебелью или продолжительного воздействия излучений, вызывающих нагревание поверхности мебели. При установке изделий мебели в непосредственной близости от нагревательных и отопительных приборов их поверхности во время эксплуатации должны быть защищены от нагрева. Температура нагрева элементов мебели не должна превышать +40 °С. Не следует ставить на поверхность горячие предметы без теплоизоляционных прокладок.
2. Во избежание возгорания не допускайте воздействия открытого огня (газовой горелки) и соприкосновения мебели с нагретыми до высокой температуры спиралями, дисками или поверхностями нагревательных приборов (электроплиток, кипятильников, электродуховок, паяльников, электрошпильцов, утюгов, каминов, обогревателей и т.п.).
3. Не допускайте прямого воздействия солнечных лучей.
4. Изделия мебели должны храниться и эксплуатироваться при относительной влажности воздуха от 40% до 70%.
5. Не допускайте при эксплуатации мебели попадания воды и иных жидкостей на элементы изделий. При монтаже моек, раковин в изделиях мебели для кухонь должна быть предусмотрена их гидроизоляция в местах контакта с поверхностью корпуса изделия мебели.
6. Не используйте для чистки и ухода препараты, содержащие аммиак, растворители, кислоты, щелочи и абразивные вещества. Для ежедневного ухода пользуйтесь салфеткой из мягкой ткани. Для удаления загрязнений достаточно протереть поверхность салфеткой, смоченной раствором жидкого (нейтрального) моющего средства в теплой воде; чтобы вывести чернильное пятно, используйте спирт. После использования этих средств необходимо все насухо вытереть. Необходимо сразу же вытирать попавшие на поверхность капли или образовавшийся пар, особенно на изделиях шкафа под мойку. Детали из стекла следует протирать салфеткой с использованием стеклоочистителей. **Внимание! При использовании химических препаратов для чистки поверхностей, рекомендуем внимательно изучить инструкцию по применению!**
7. Механизмы открывания и трансформации (дверей, ящиков, кроватей) требуют постоянного ухода. В качестве профилактических мер рекомендуем: периодически осуществлять «затяжку» всех изделий металлофурнитуры, осуществляющих крепеж и регулировку узлов, обеспечивающих открывание и трансформацию подвижных элементов; без необходимости не держать открытыми навесные и врезные механизмы, обеспечивающие фиксацию подвижных элементов (дверей, ящиков и т.п.);
8. Не допускать нагрузок, не предусмотренных производителем для данного элемента конструкции (не выгибать двери и не навешивать на них одежду, не переламывать замки и т.п.);
9. Не перемещать конструктивно законченные элементы мебели с места на место, чтобы избежать нарушения жесткости конструкции. Не перемещать мебель волоком в целях исключения появления различного рода механических повреждений, перемещение мебели осуществлять поднятием с одновременным переносом.

ГАРАНТИЙНЫЕ ОБЯЗАТЕЛЬСТВА

1. Предприятие-изготовитель гарантирует соответствие изделий мебели требованиям технического регламента Таможенного союза ТР ТС 025/2012 «О безопасности мебельной продукции» и ГОСТ 16371-2014 «Мебель. Общие технические условия», ГОСТ 19917-2014 «Мебель для сидения и лежания. Общие технические условия» при соблюдении условий правильной сборки, эксплуатации и ухода за мебелью.
2. Гарантийный срок исчисляется со дня продажи изделия. Если день передачи товара потребителю установить невозможно, гарантийный срок исчисляется со дня изготовления мебели. Дефекты производственного характера, обнаруженные в течение гарантийного срока, устраняются за счёт предприятия-изготовителя.
3. Гарантия не распространяется на мебель, имеющую повреждения:
 - механические (изломы, царапины, трещины и др.), возникшие в процессе неправильной сборки и эксплуатации; имеет следы постороннего вмешательства в конструкцию или была попытка ремонта;
 - вызванные стихией, пожаром и бытовыми факторами;
 - вызванные попаданием на поверхность и кромки изделий воды, едких веществ и жидкостей (разбухание, изменение цвета и рисунка).
4. Гарантия не распространяется на мебель, если обнаружены несанкционированные изменения конструкции или изделие эксплуатировалось не в соответствии со своим целевым назначением или в условиях, для которых оно не предназначено.
5. Гарантия не распространяется также на мебель, не имеющую штампа ОТК в Свидетельстве о приёмке.
Дефектами мебели не являются: незначительная разнооттеночность и разнофактурность защитно-декоративных покрытий, тканей и кожзаменителей; «бликование» их при изменении освещённости; лёгкие складки на облицовочном материале мягких элементов, возникшие после снятия нагрузок и исчезающие после разглаживания рукой; потёртости мебельных покрытий, возникшие в результате эксплуатации мебели.

СВИДЕТЕЛЬСТВО О ПРИЁМКЕ

Изделие изготовлено в соответствии с обязательными требованиями НТД и признано годным для эксплуатации

**Набор мебели бытовой корпусной «Модерн»
Кровать двухъярусная ЛД.520010.000**

Штамп ОТК

Дата изготовления

Декларация о соответствии ЕАЭС № RU Д-РУ.АЖ16.В.16445.
Срок действия по 13.02.2021г.