

**20.00.1800.00**

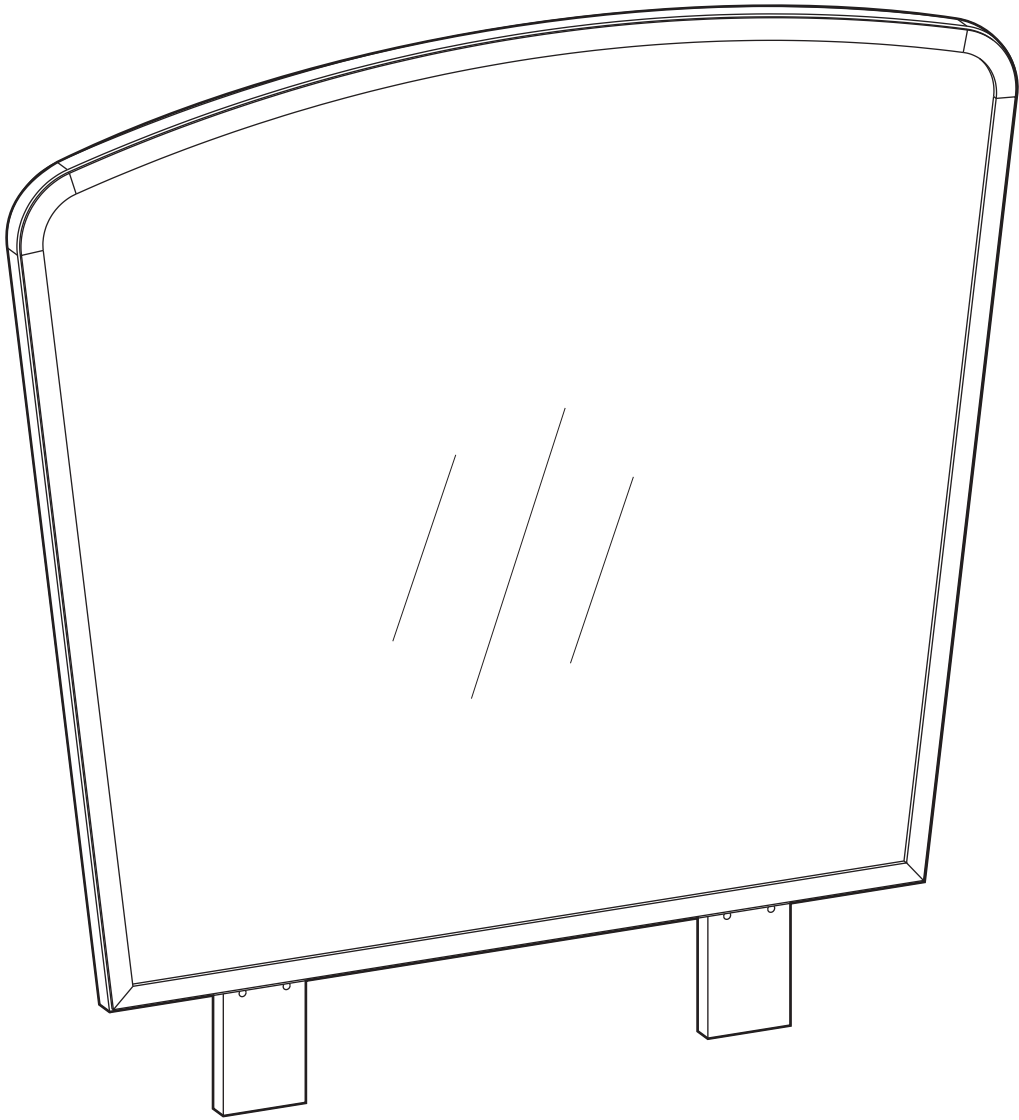

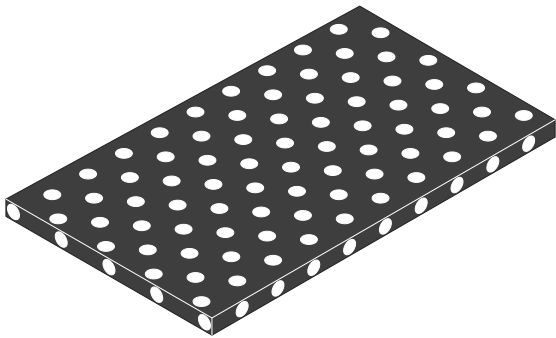

1 / 1

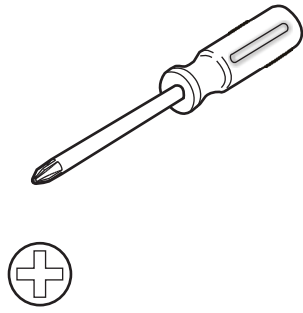
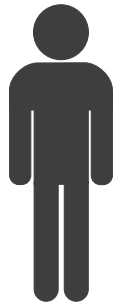
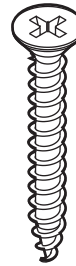

AA

13.02.01.007 x 6

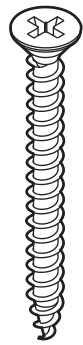

AB

13.02.01.009 x 4

1 / 1

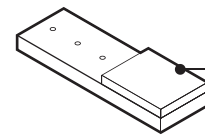
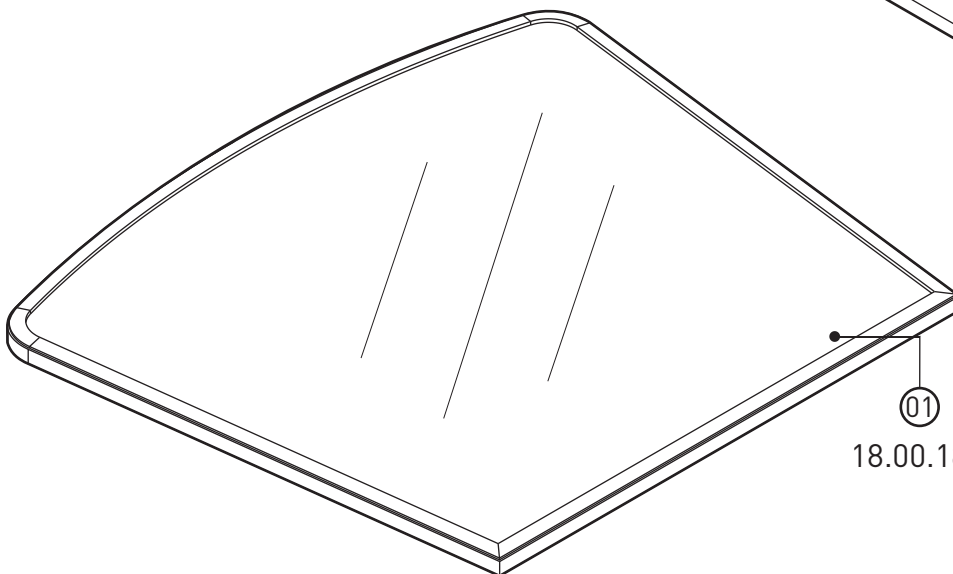

02

18.00.1800.002x 2

01

18.00.1800.001x 1

1

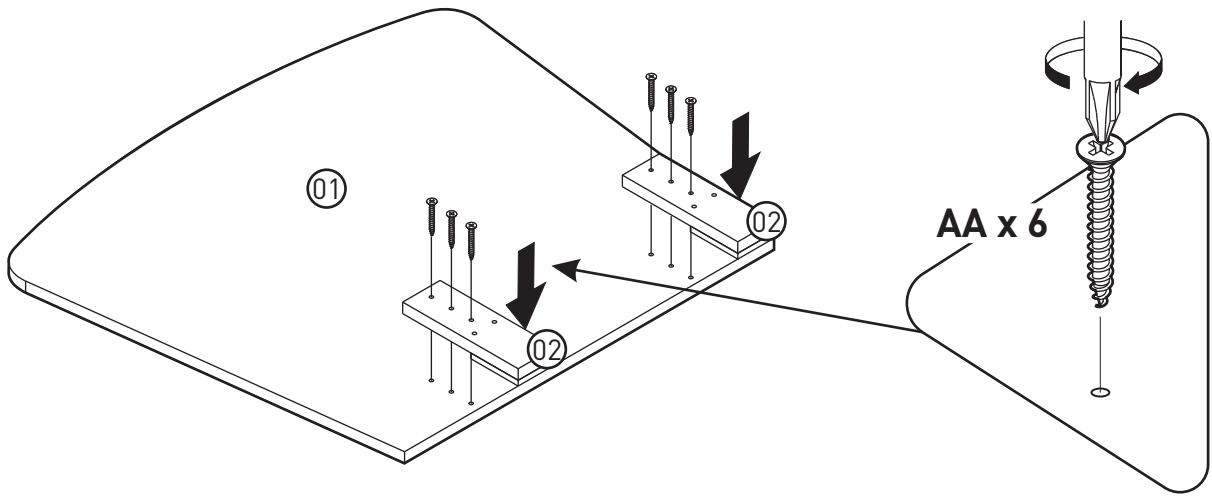

2

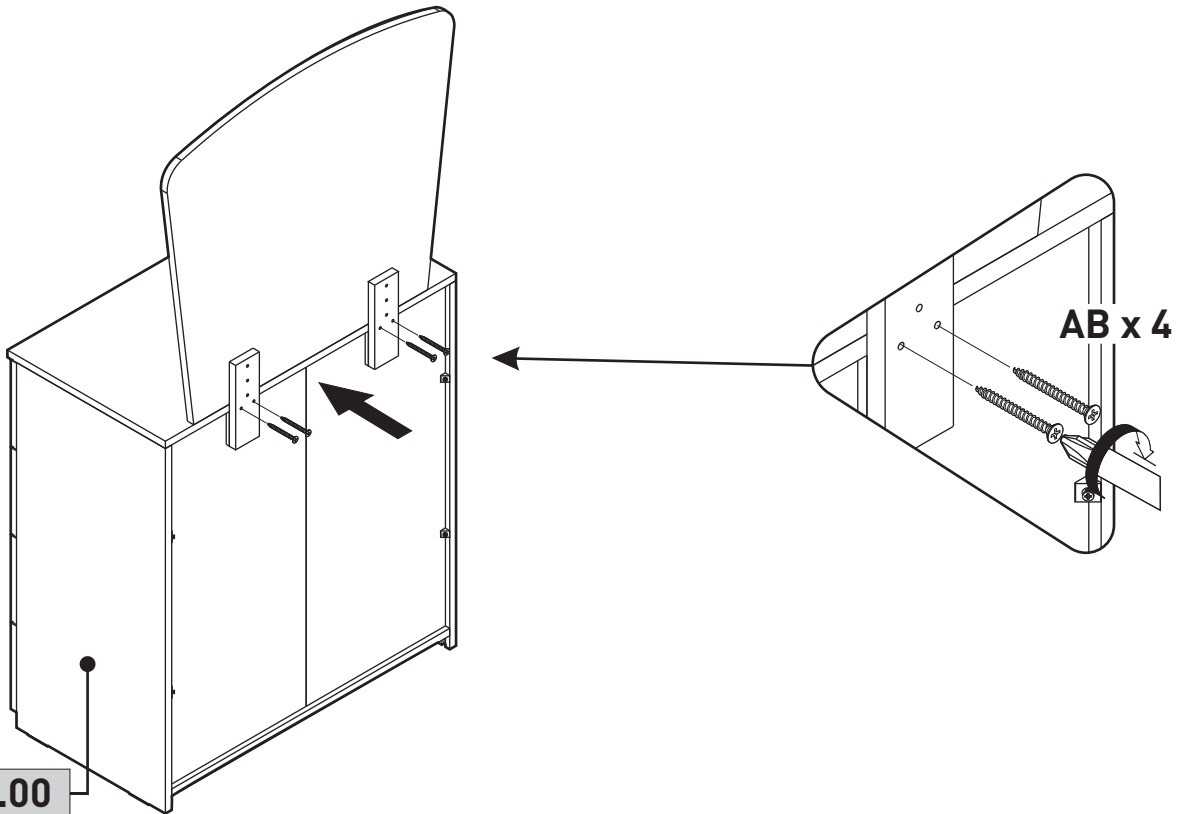

20.04.1202.00  
20.05.1202.00