

20.21.1201.01

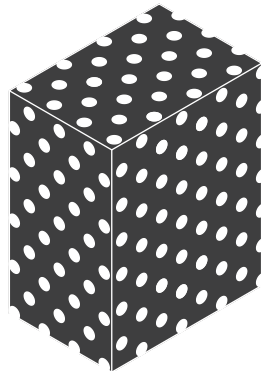

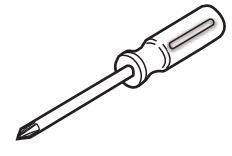

2 / 1

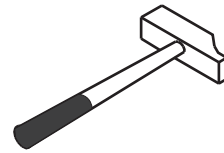
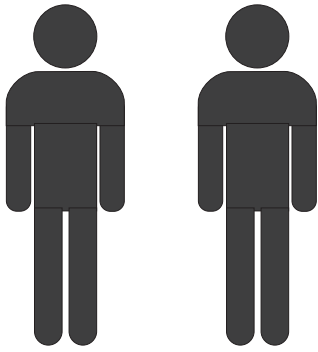
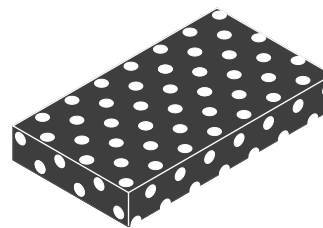

2 / 2

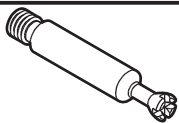

13.07.01.108 x 8

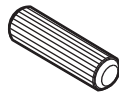

13.01.01.111 x 16



13.07.01.110 x 8

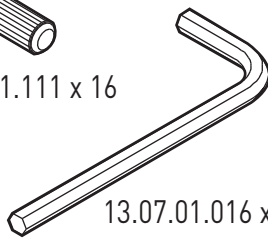

13.07.01.016 x 1



13.03.01.010 x 8

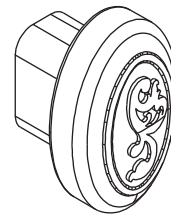

13.06.01.116 x 8

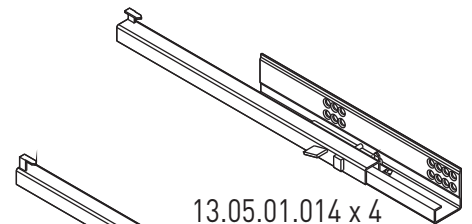

13.05.01.014 x 4

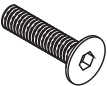

13.03.01.034 x 4



13.01.01.045 x 8



13.02.01.018 x 16

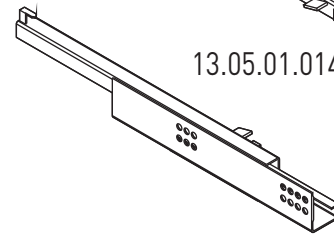

13.05.01.015 x 4

2 / 1

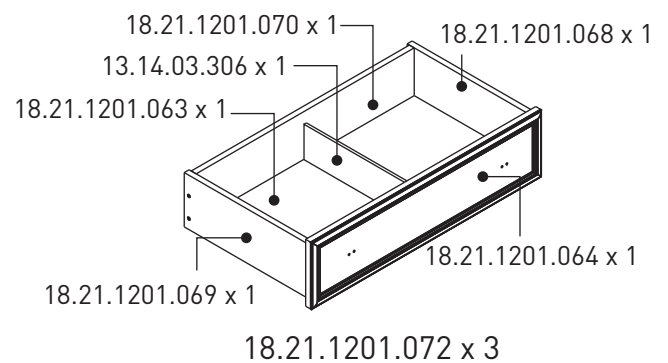
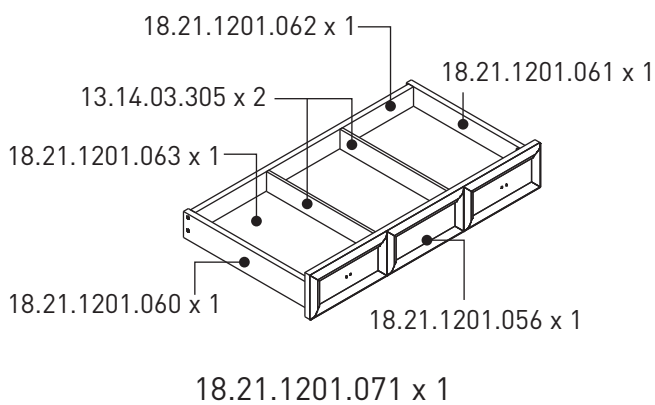

13.01.01.293 x 4

2/2

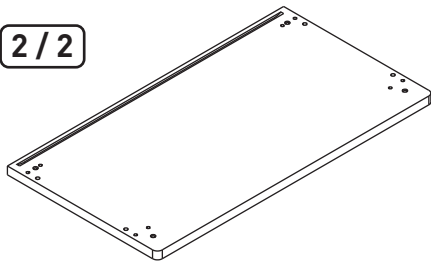

18.21.1201.051 x 1

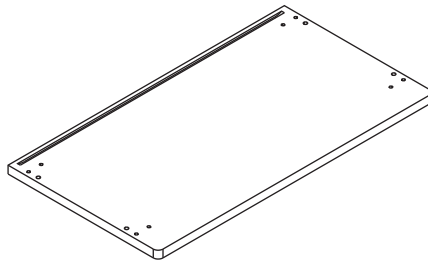

18.21.1201.055 x 1

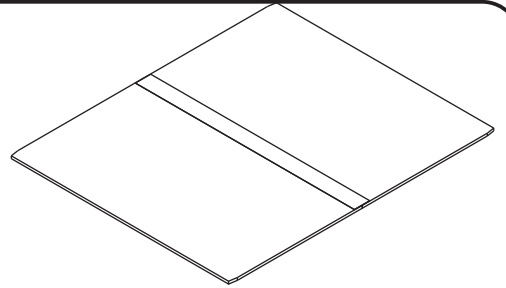

18.21.1201.024 x 1

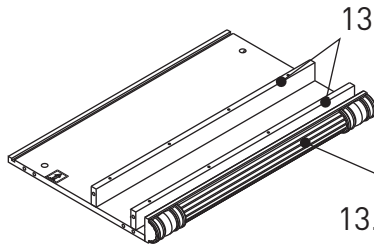

18.21.1201.052 x 1

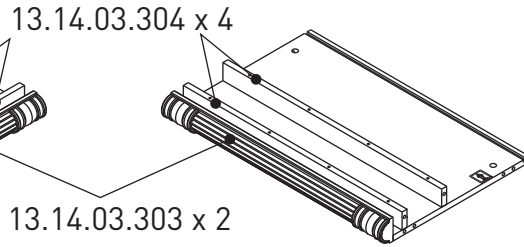

18.21.1201.054 x 1

13.14.03.304 x 4

13.14.03.303 x 2

1

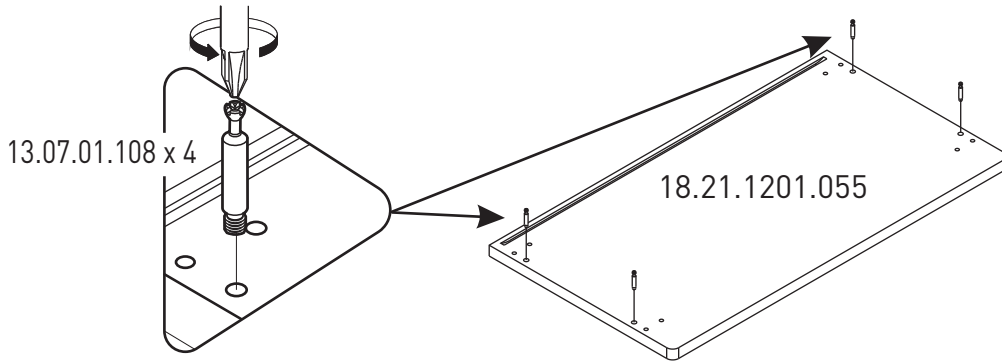

2

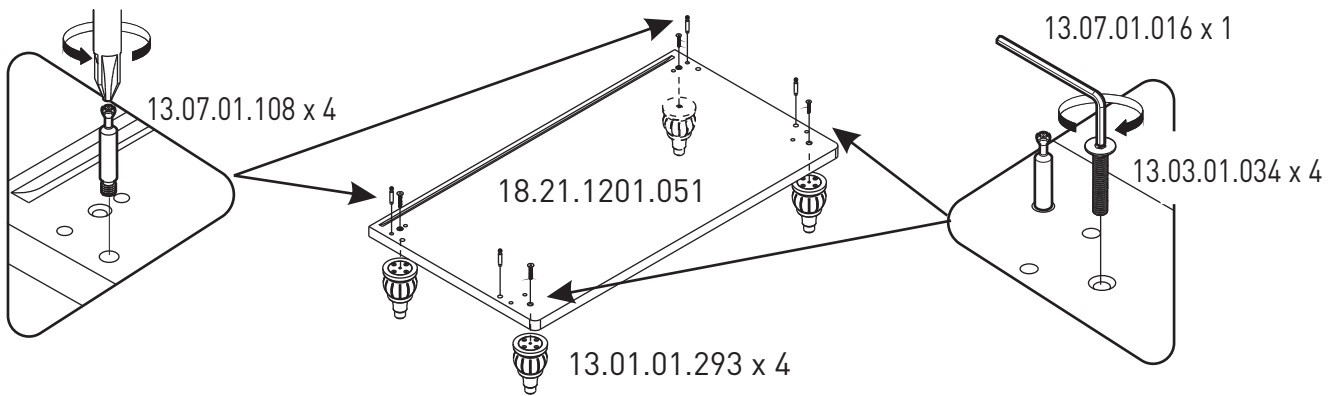

3

